

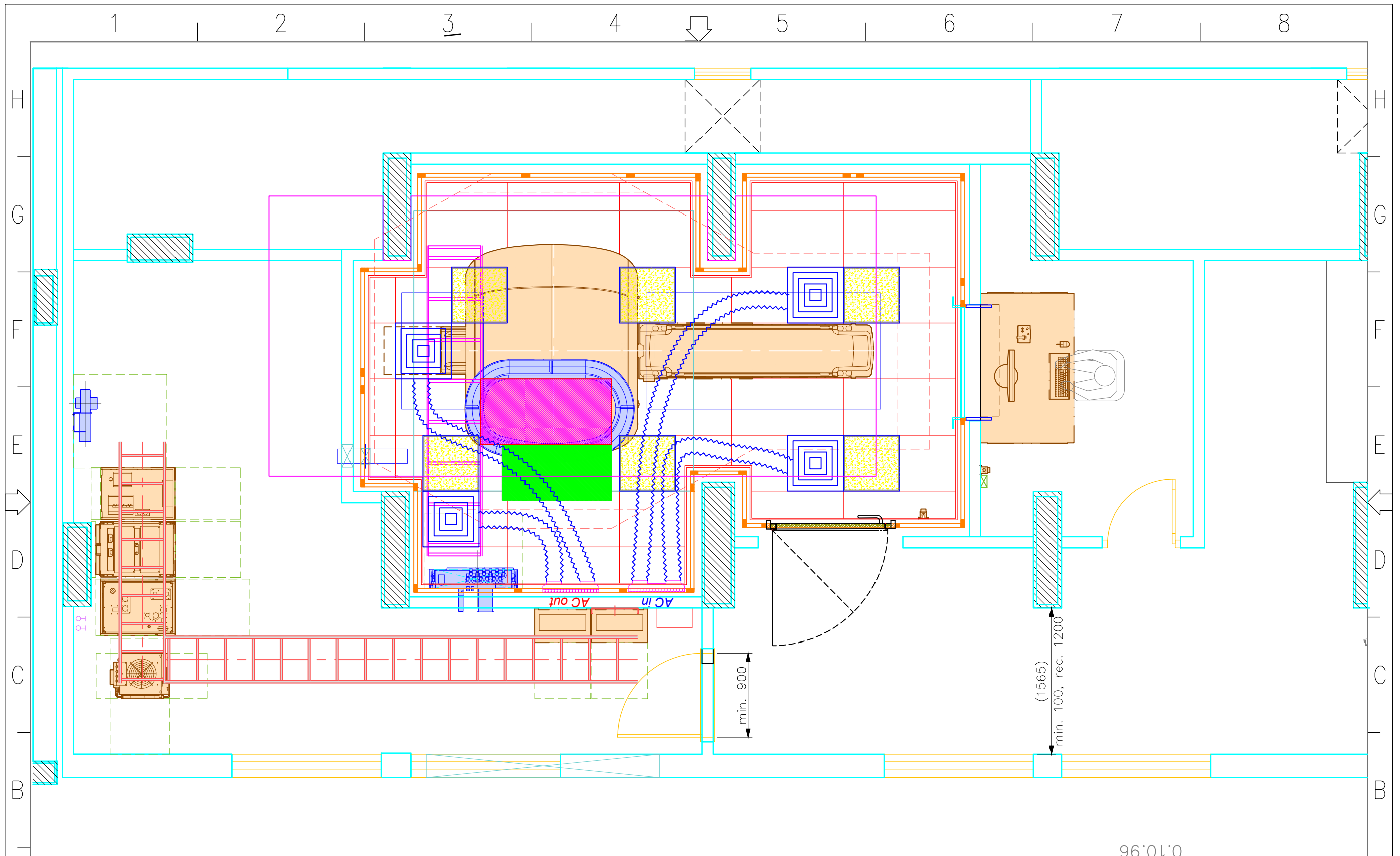

RF ENCLOSURE SHOP DRAWING

Page	Page Description
0	Drawing Sheet Index
1	Top view
2	Magnet Position
3	Ground opening
4	Lightning Panels- Anemostat
5	View -A Structural
6	View -A Interior Finishing
7	View -B Structural
8	View -B Interior Finishing
9	View -C Structural
10	View -C Interior Finishing
11	Suspended Ceiling
12	CableTray
13	Wall Panels Top View
14	Wall Panels Fronte View-A
15	Wall Panels Left View-B
16	Wall Panels Behind View-C
17	Wall Panels Right View-D
18	Wall Panels Details
19	Ceiling Panels Details
20	Lower floor ground 18mm MDF
21	Upper floor ground 18mm MDF
22	Magnet Shielding
23	Magnet Shielding-A
24	RF Enclosure Details, Wall Panel
25	<i>RF Enclosure Details, (Door)</i>
26	<i>RF Enclosure Details, (Window)</i>
	System filter BOX
28	Room lighting drawing



96'01"0

Project No: 2020xxx		Dwg No: -	Customer/Project Name	TOP VIEW	Page	 CONTRACTING & SERVICES
Rev No: 2		Dwg By: -	Model Type Ingenia Ambition S		1	
Date: 02.11.2022	All dimensions are millimeters.					
Scale 1/50	Size A3					



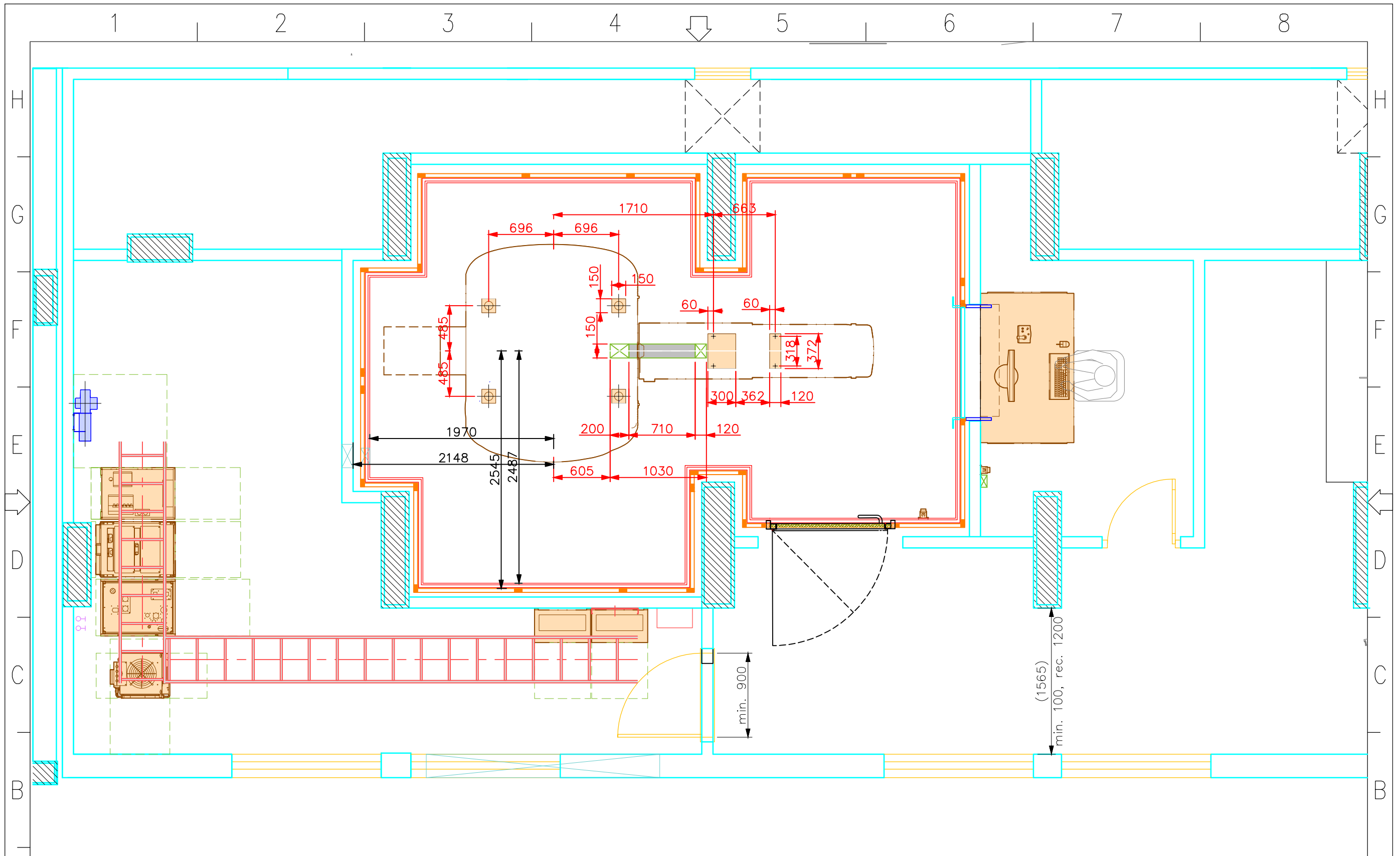

Project No: 2020xxx		Dwg No: -	Customer/Project Name	<h1>Magnet Position</h1>	Page	 CONTRACTING & SERVICES
Rev No: 2		Dwg By: -	Model Type Ingenia Ambition S		2	
Date: 02.11.2022	All dimensions are millimeters.					
Scale 1/50	Size A3					

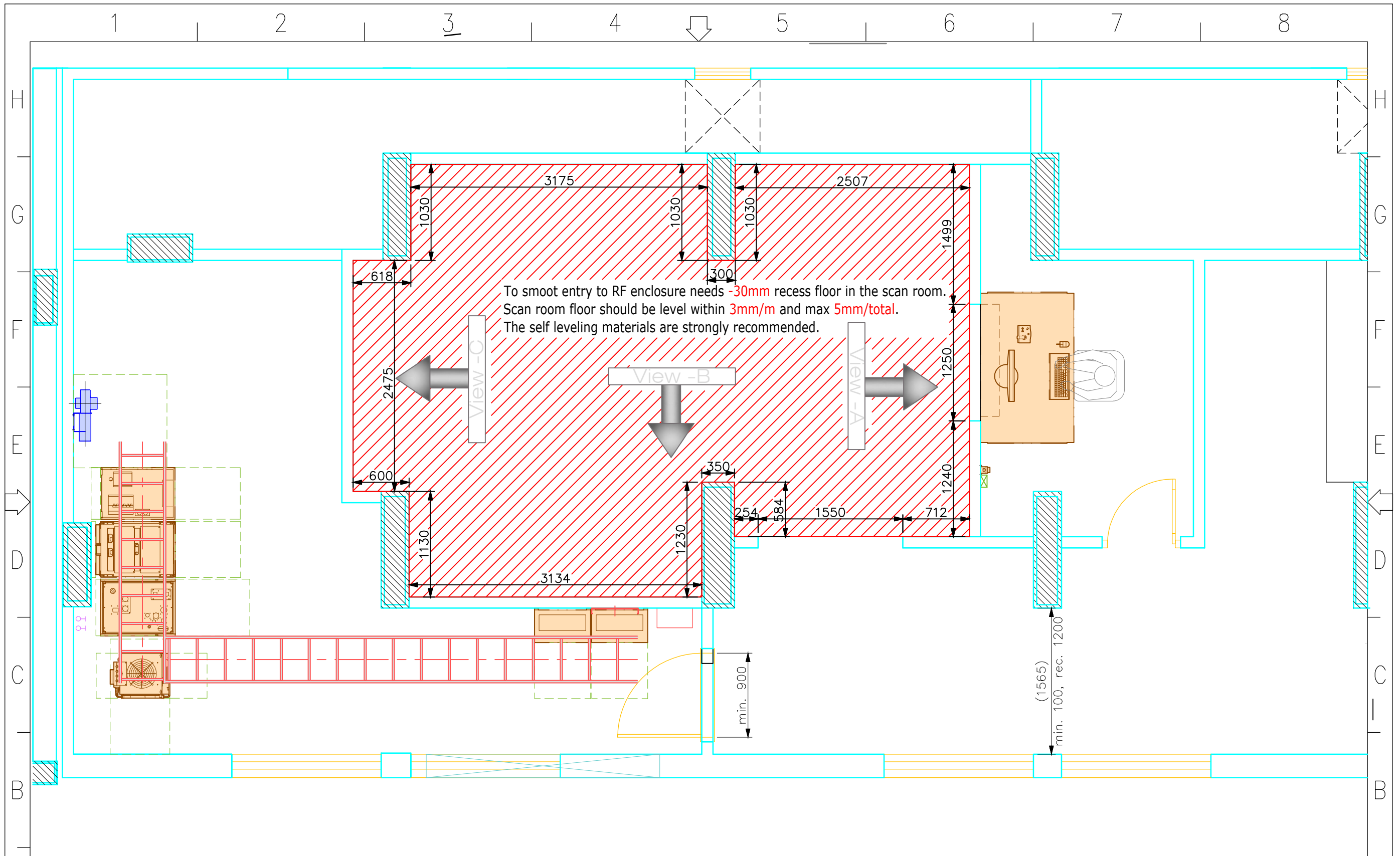

Project No: 2020xxx	Dwg No: -	Customer/Project Name	Ground opening	Page	 CONTRACTING & SERVICES
Rev No: 2	Dwg By: -	Model Type Ingenia Ambition S		3	
Date: 02.11.2022	All dimensions are millimeters.				
Scale 1/50	Size A3				

A

A

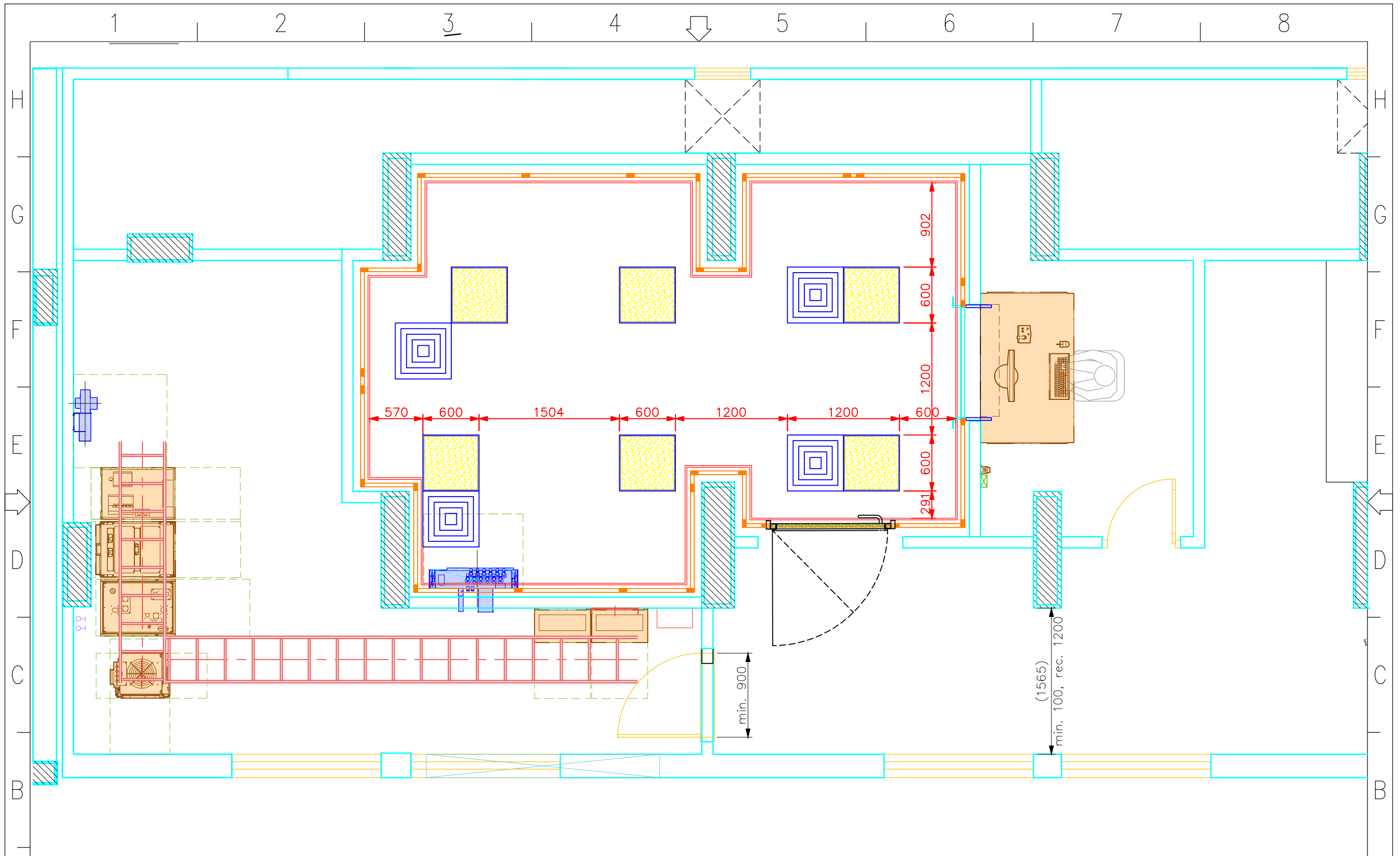

Project No: 2020xxx		Dwg No: -		Customer/Project Name		Page		
Rev No: 2		Dwg By: -		Model Type Ingenia Ambition S		4		
Date: 02.11.2022		All dimensions are millimeters.						
Scale 1/50	Size A3							

Lightning Panels- Anemostat

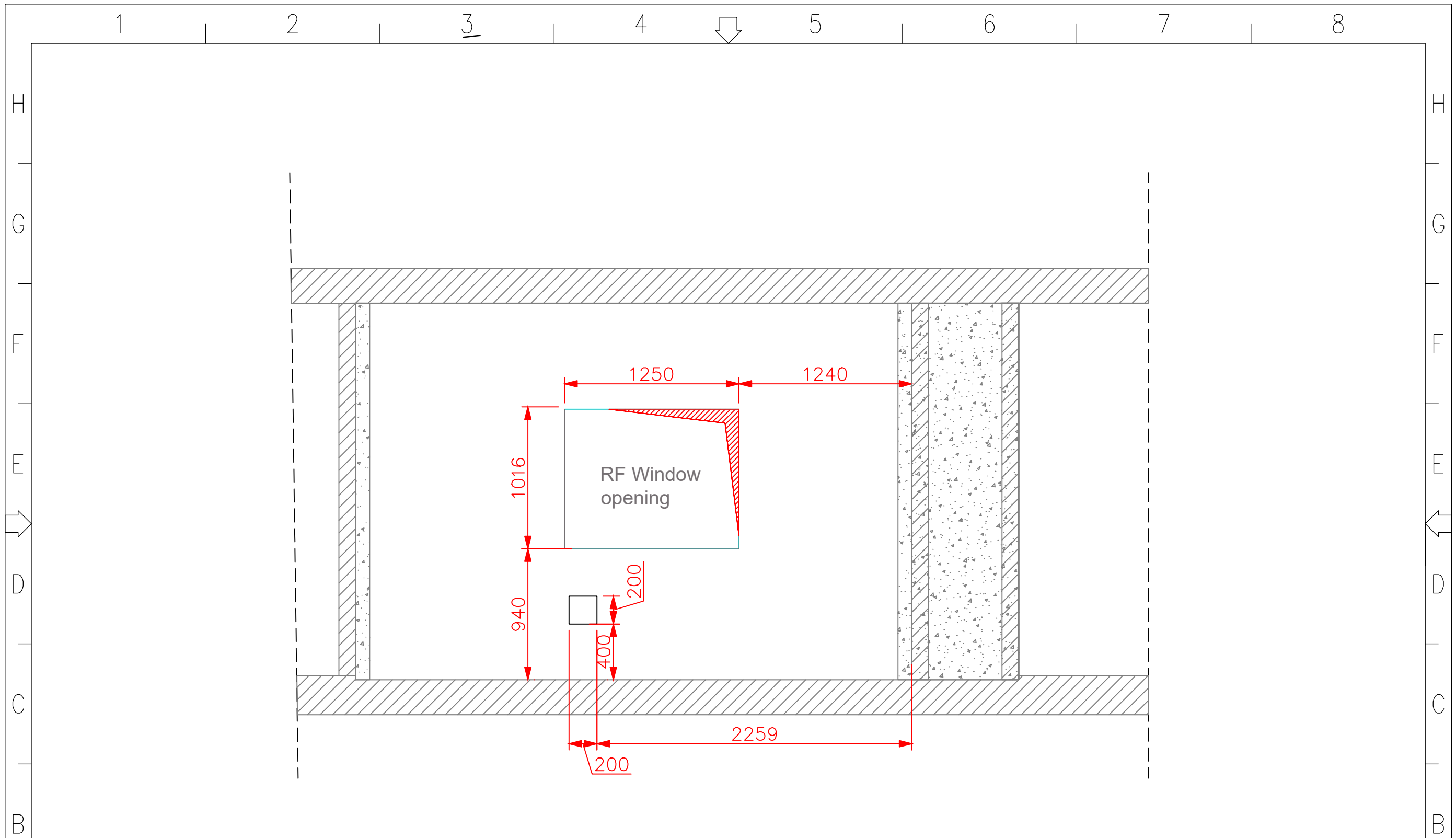

Note: All the scales are millimeters and from inside of the scan room.

Project No: 2020xxx		Dwg No: -	Customer/Project Name	View -A Structural	Page	 CONTRACTING & SERVICES
Rev No: 2		Dwg By: -	Model Type		5	
Date: 02.11.2022		Ingenia Ambition S				
Scale 1/50	Size A3	All dimensions are millimeters.				

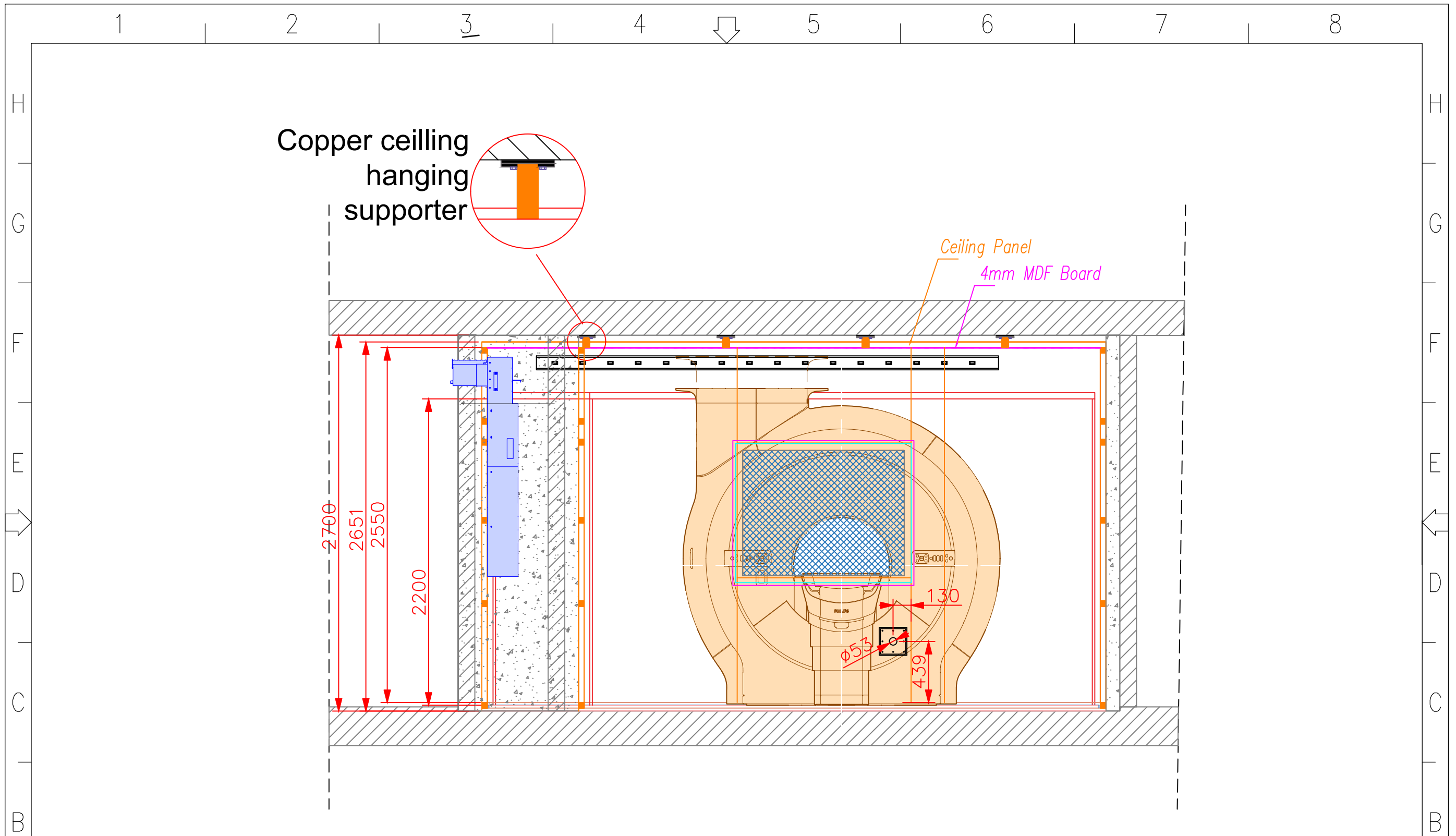

Note: RF viewed from the outside!

Project No: 2020xxx		Dwg No: -	Customer/Project Name	Page 6	
Rev No: 2		Dwg By: -	Model Type Ingenia Ambition S		
Date: 02.11.2022	All dimensions are millimeters.				
Scale 1/50	Size A3				

View -A Interior Finishing

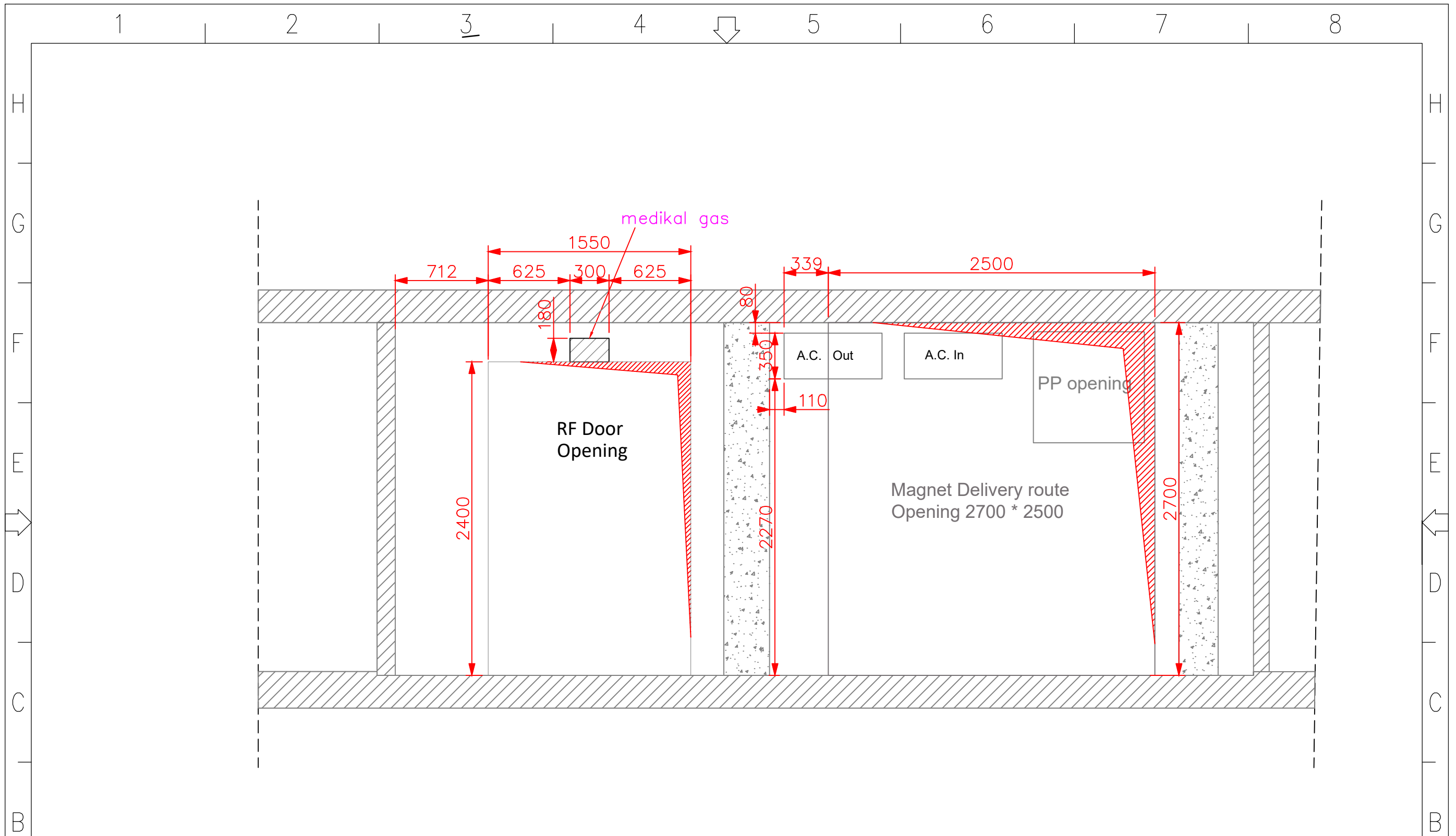

Note: All the scales are millimeters and from inside of the scan room.

Project No: 2020xxx		Dwg No: -	Customer/Project Name		Page	 ceren CONTRACTING & SERVICES
Rev No: 2						
Date: 02.11.2022		Dwg By: -	Model Type			
Scale 1/50	Size A3	All dimensions are millimeters.		Ingenia Ambition S		

View -B Structural

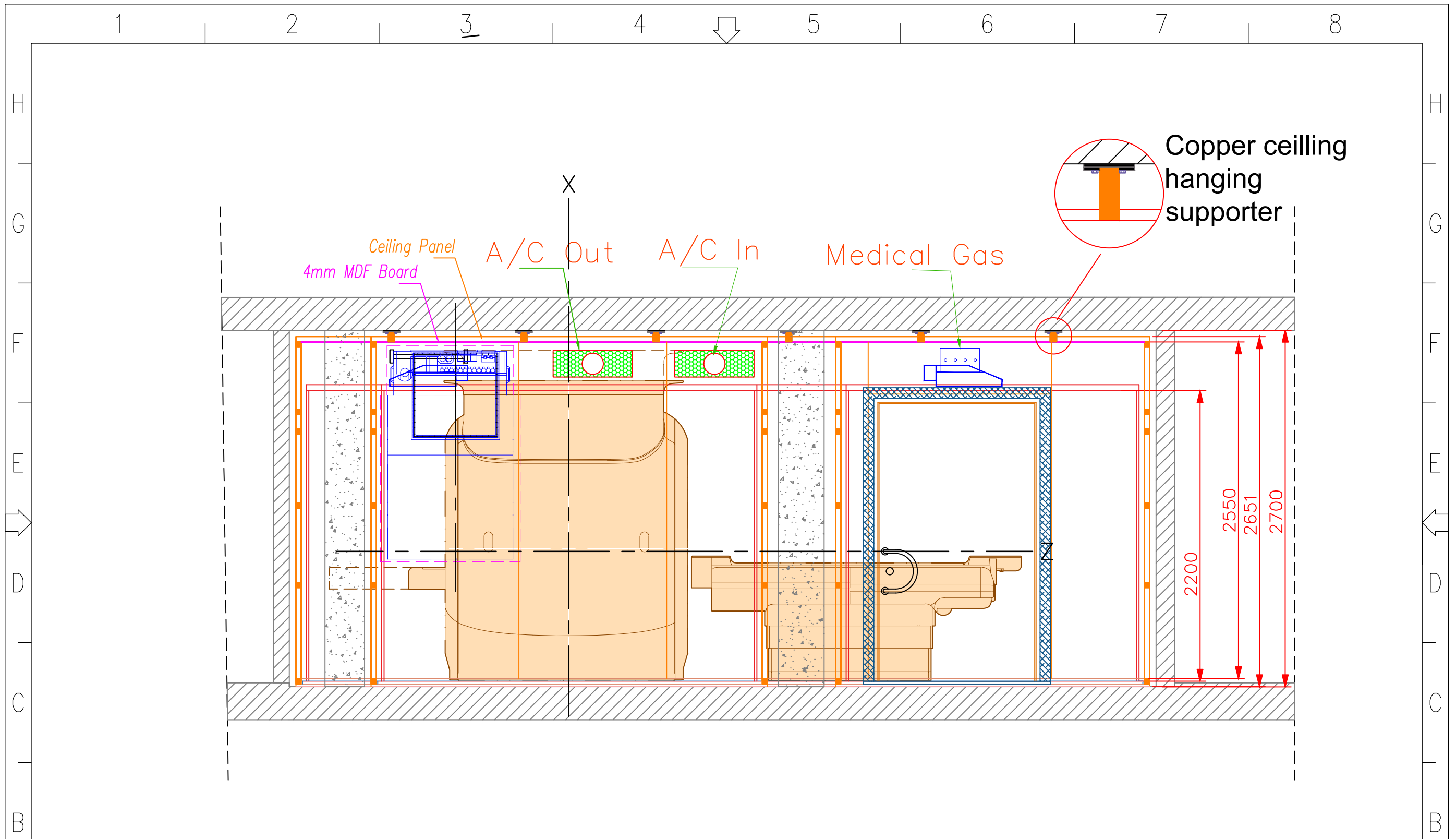

Note: RF viewed from the outside!

Project No: 2020xxx		Dwg No: -	Customer/Project Name	View -B Interior Finishing	Page	 CONTRACTING & SERVICES
Rev No: 2		Dwg By: -	Model Type		8	
Date: 02.11.2022			Ingenia Ambition S			
Scale 1/50	Size A3	All dimensions are millimeters.				

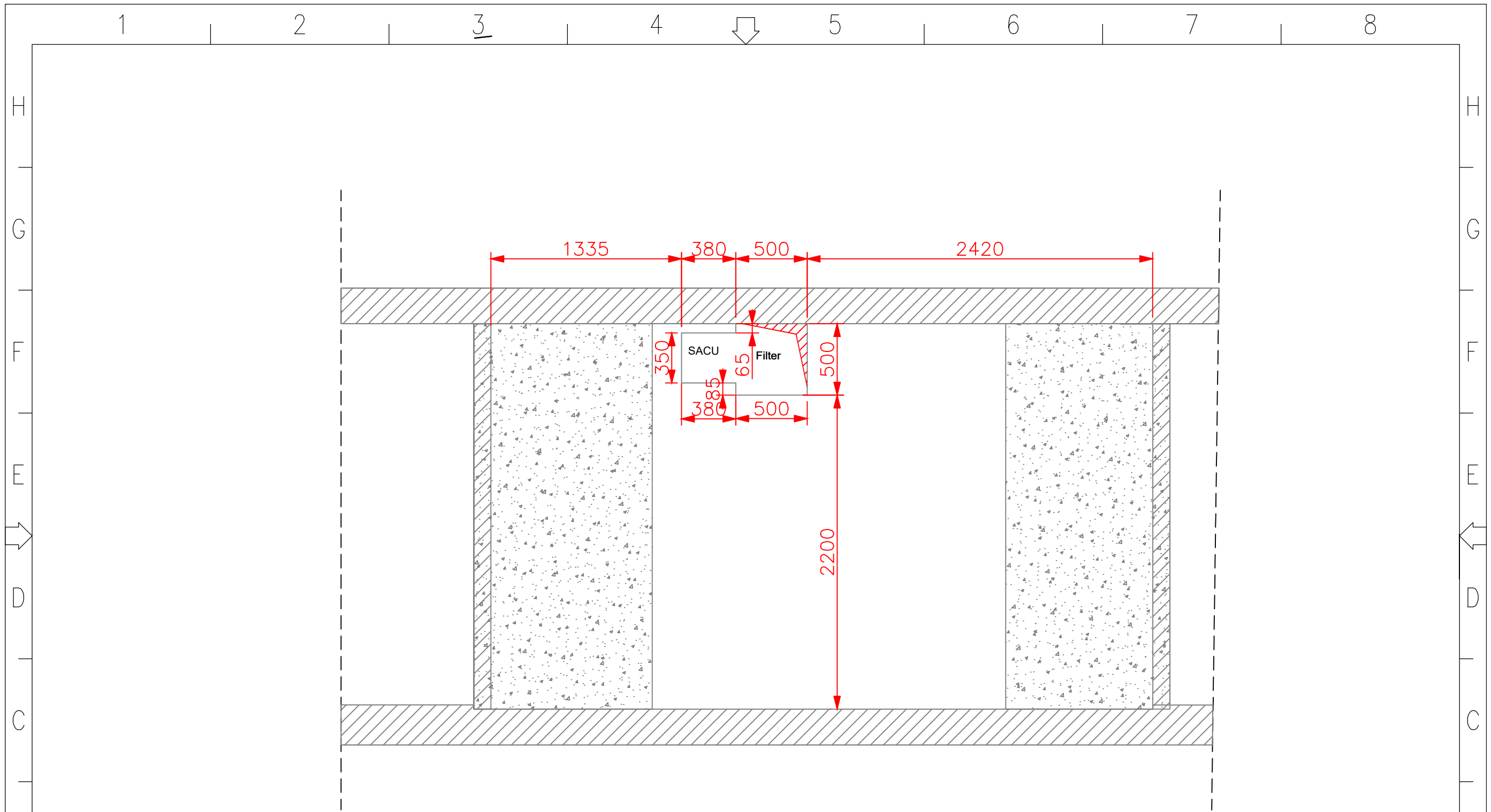

Note: All the scales are millimeters and from inside of the scan room.

Project No: 2020xxx		Dwg No: -	Customer/Project Name	View -C Structural	Page	 CONTRACTING & SERVICES
Rev No: 2		Dwg By: -	Model Type		9	
Date: 02.11.2022		Ingenia Ambition S				
Scale 1/50	Size A3	All dimensions are millimeters.				

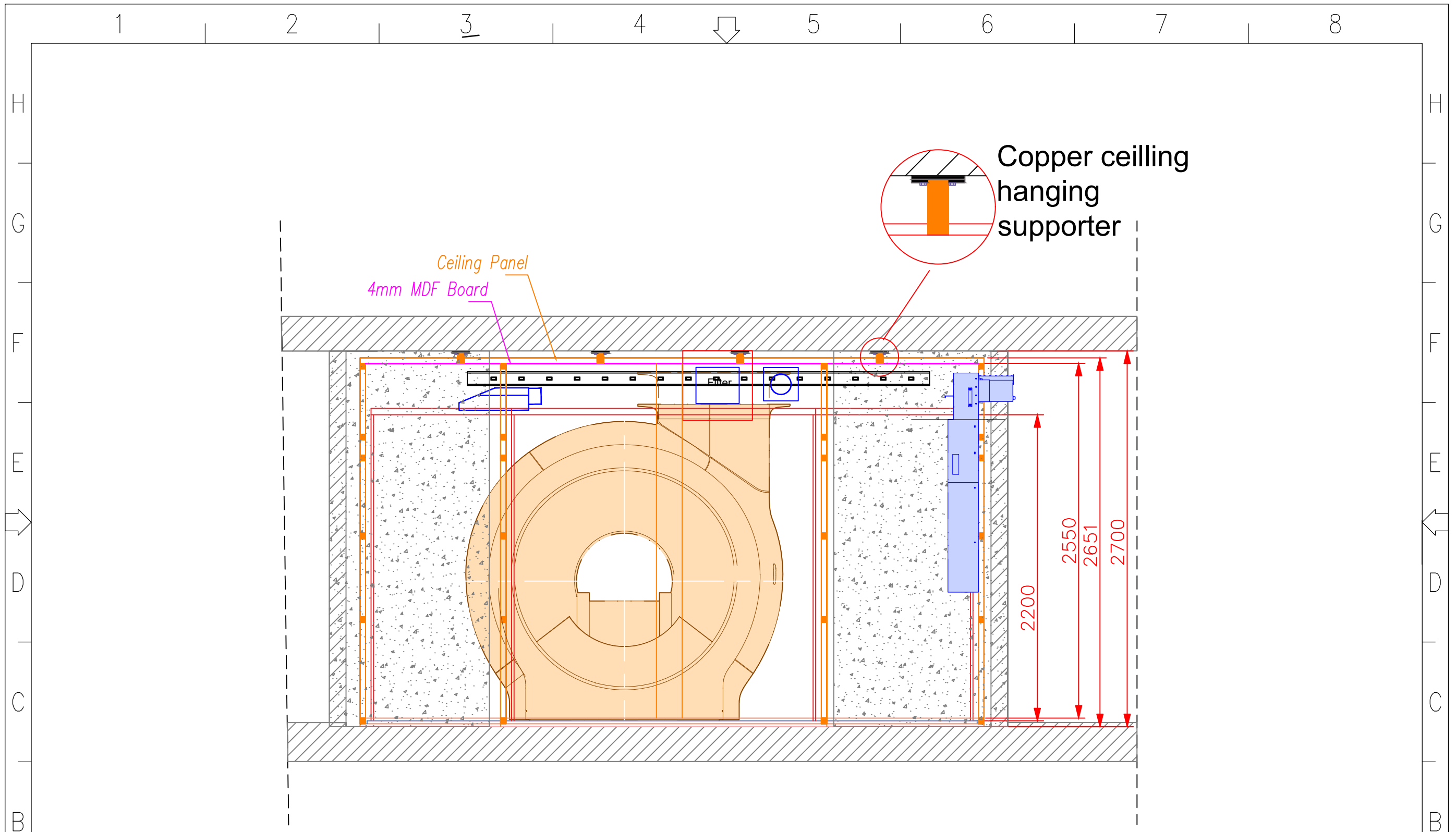

Note: RF viewed from the outside!

Project No: 2020xxx		Dwg No: -	Customer/Project Name	View -C Interior Finishing	Page	 CONTRACTING & SERVICES
Rev No: 2		Dwg By: -	Model Type		10	
Date: 02.11.2022		All dimensions are millimeters.	Ingenia Ambition S			
Scale 1/50	Size A3					

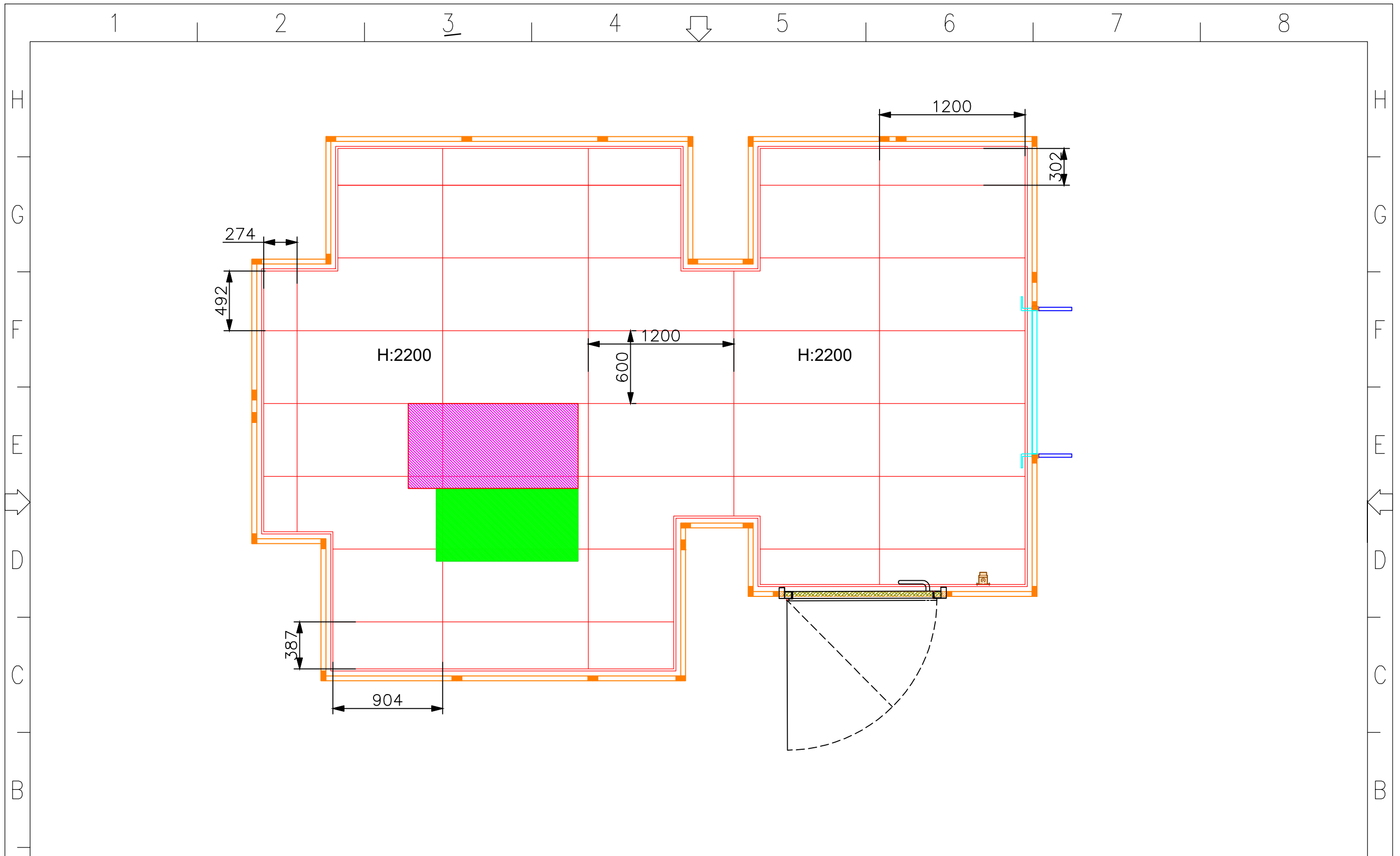

Project No: 2020xxx		Dwg No: -	Customer/Project Name	SUSPENDED CEILING	Page	 CONTRACTING & SERVICES
Rev No: 2		Dwg By: -	Model Type Ingenia Ambition S		11	
Date: 02.11.2022	Scale 1/50	Size A3	All dimensions are millimeters.			

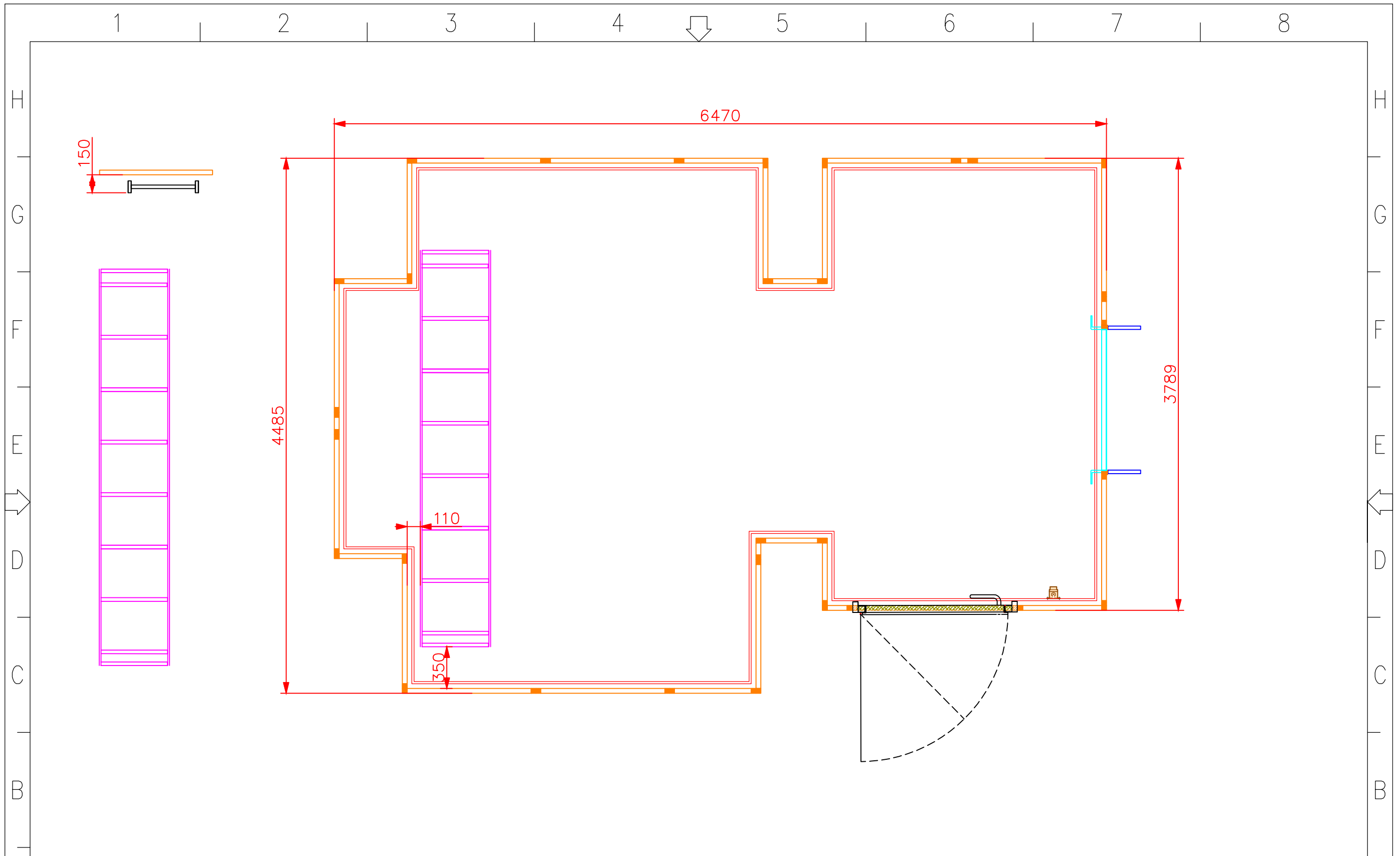

Project No:
2020xxx

Rev No: 2

Date: 02.11.2022

Scale
1/50

Dwg No: -

Dwg By: -

All dimensions are millimeters.

Customer/Project Name

Model Type
Ingenia Ambition S

CABLE TRAY

Page
12



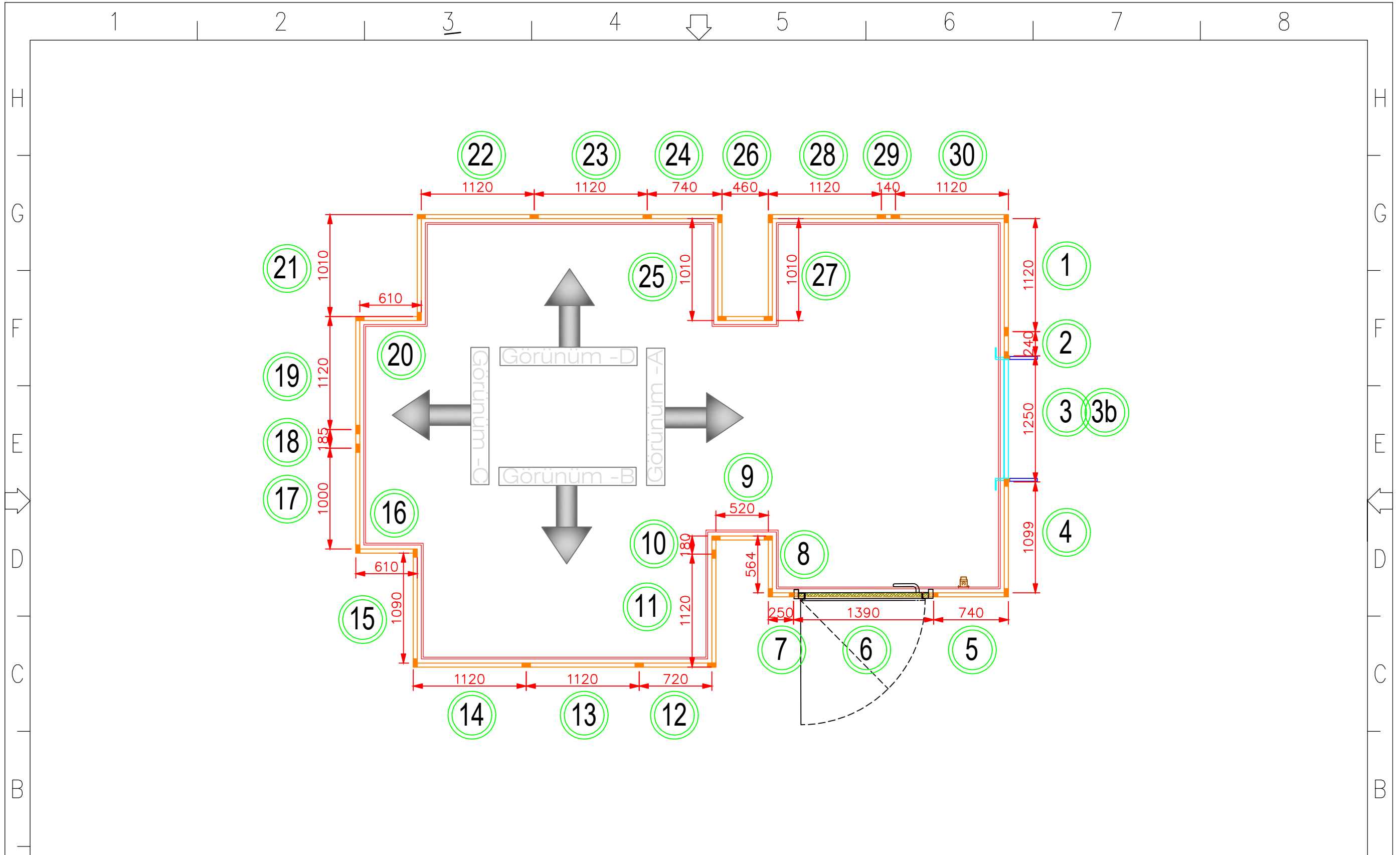

Project No: 2020xxx		Dwg No: -	Customer/Project Name
Rev No: 2			
Date: 02.11.2022		Dwg By: -	Model Type Ingenia Ambition S
Scale 1/50	Size A3		

WALL PANELS TOP VIEW

Page

13



A

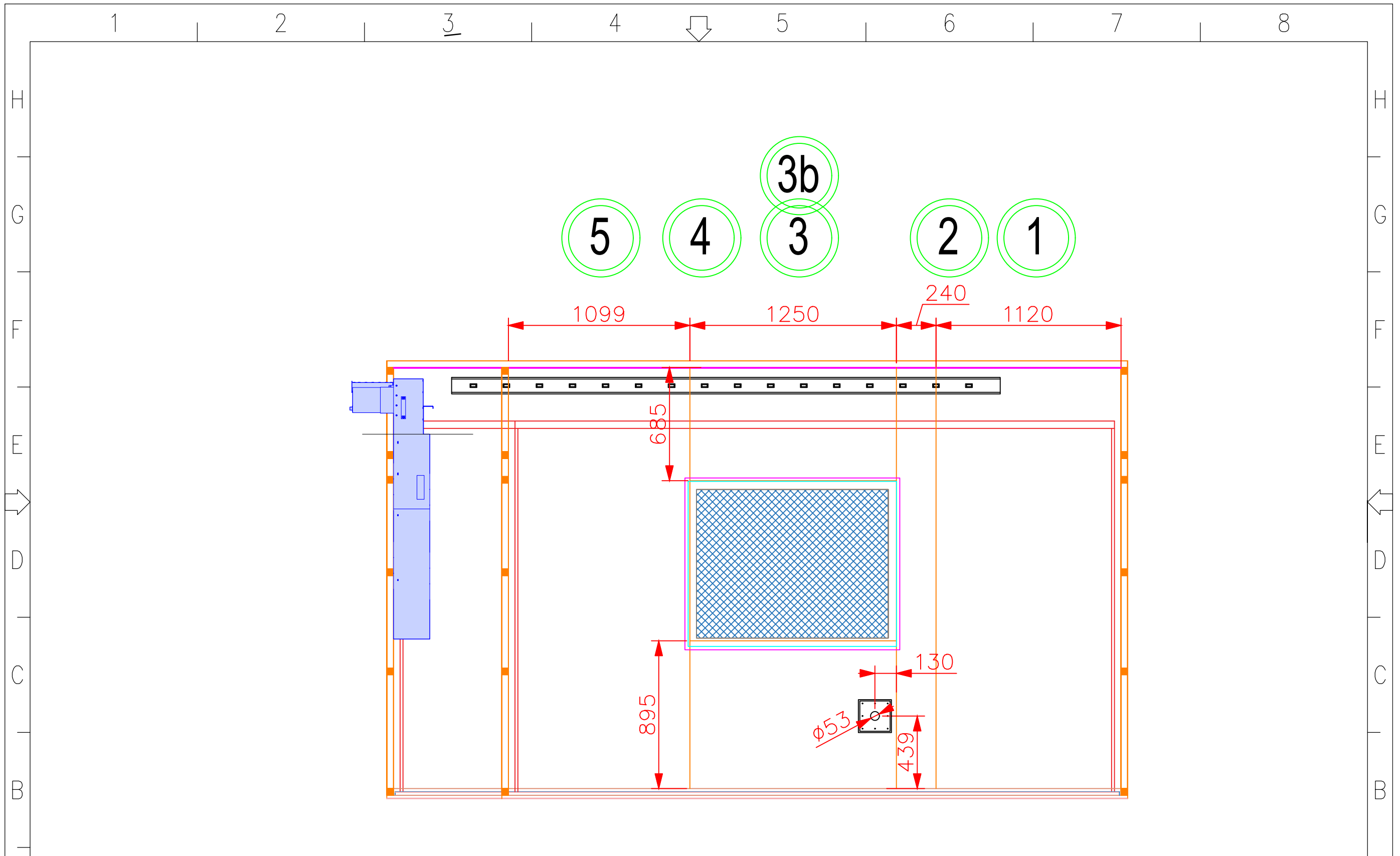

Project No: 2020xxx		Dwg No: -	Customer/Project Name
Rev No: 2			
Date: 02.11.2022		Dwg By: -	Model Type Ingenia Ambition S
Scale 1/50	Size A3		

Dwg No: -		Customer/Project Name
Dwg By: -		
All dimensions are millimeters.		Model Type Ingenia Ambition S

WALL PANELS FRONTE VIEW-A

Page

14



A

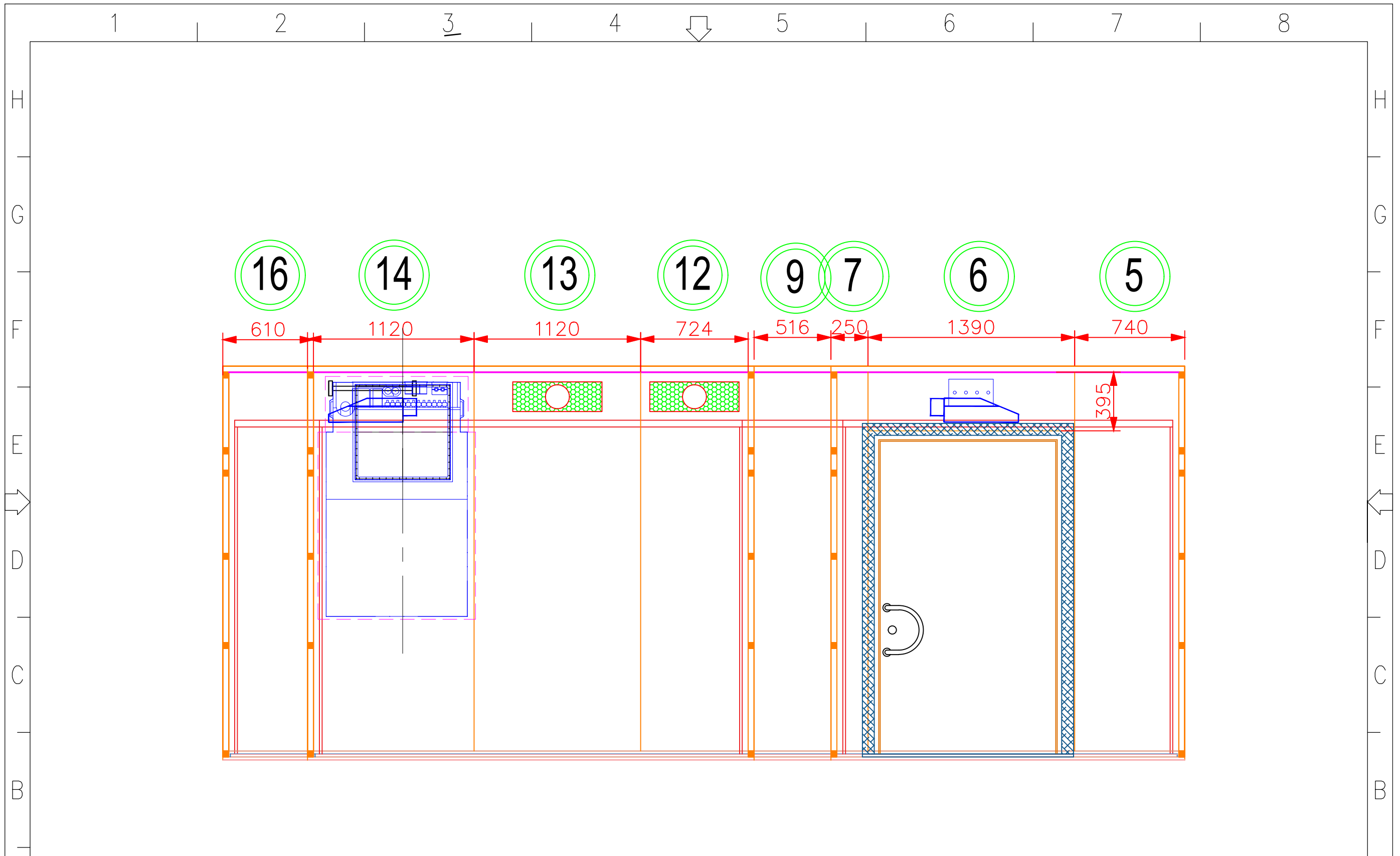

Project No: 2020xxx	Dwg No: -	Customer/Project Name
Rev No: 2	Dwg By: -	Model Type Ingenia Ambition S
Date: 02.11.2022	All dimensions are millimeters.	
Scale 1/50	Size A3	

WALL PANELS LEFT VIEW-B



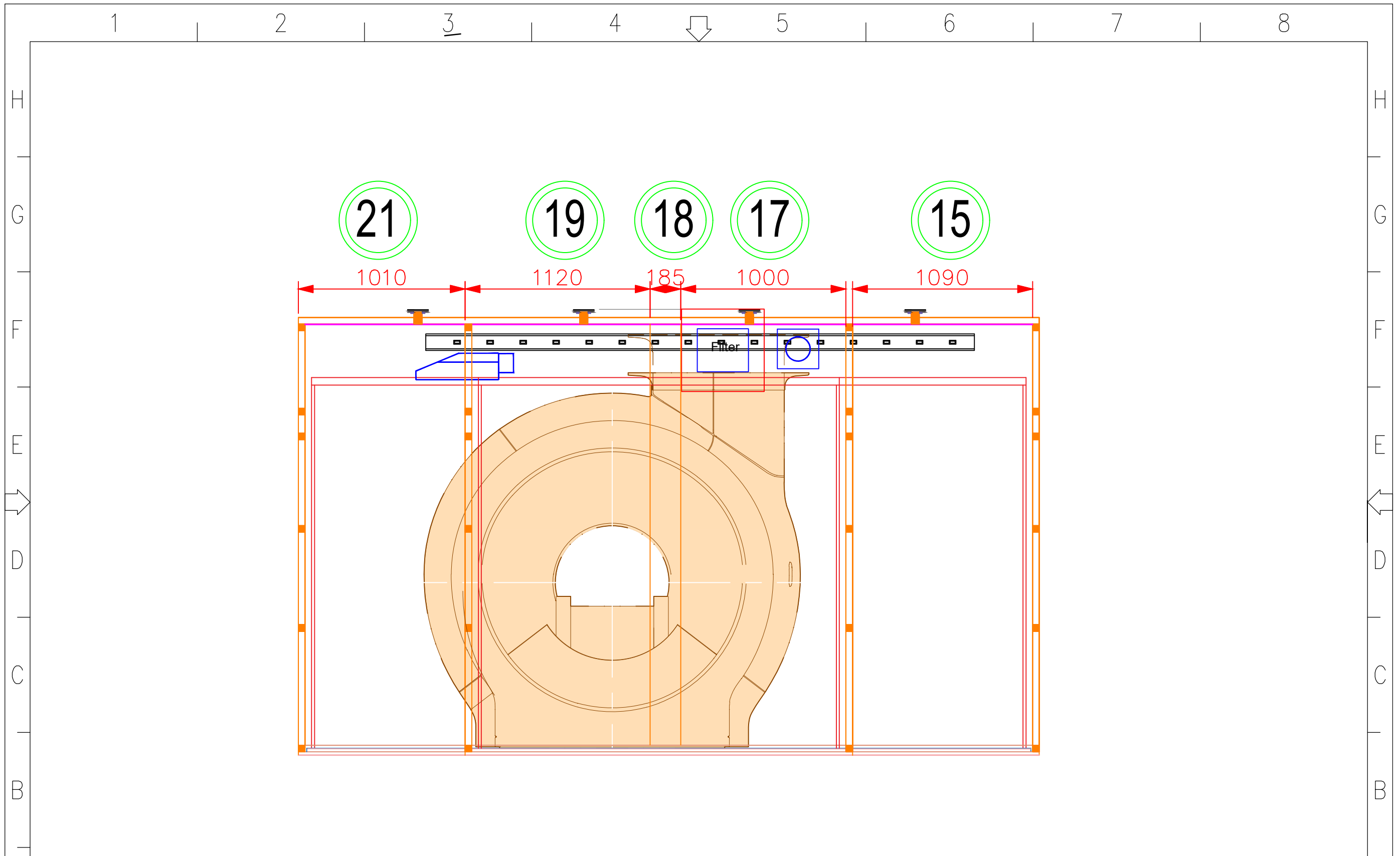

Project No:
2020xxx

Rev No: 2

Date: 02.11.2022

Scale
1/50

Dwg No: -

Dwg By: -

All dimensions are millimeters.

Customer/Project Name

Model Type
Ingenia Ambition S

WALL PANELS BEHIND VIEW-C

Page
16



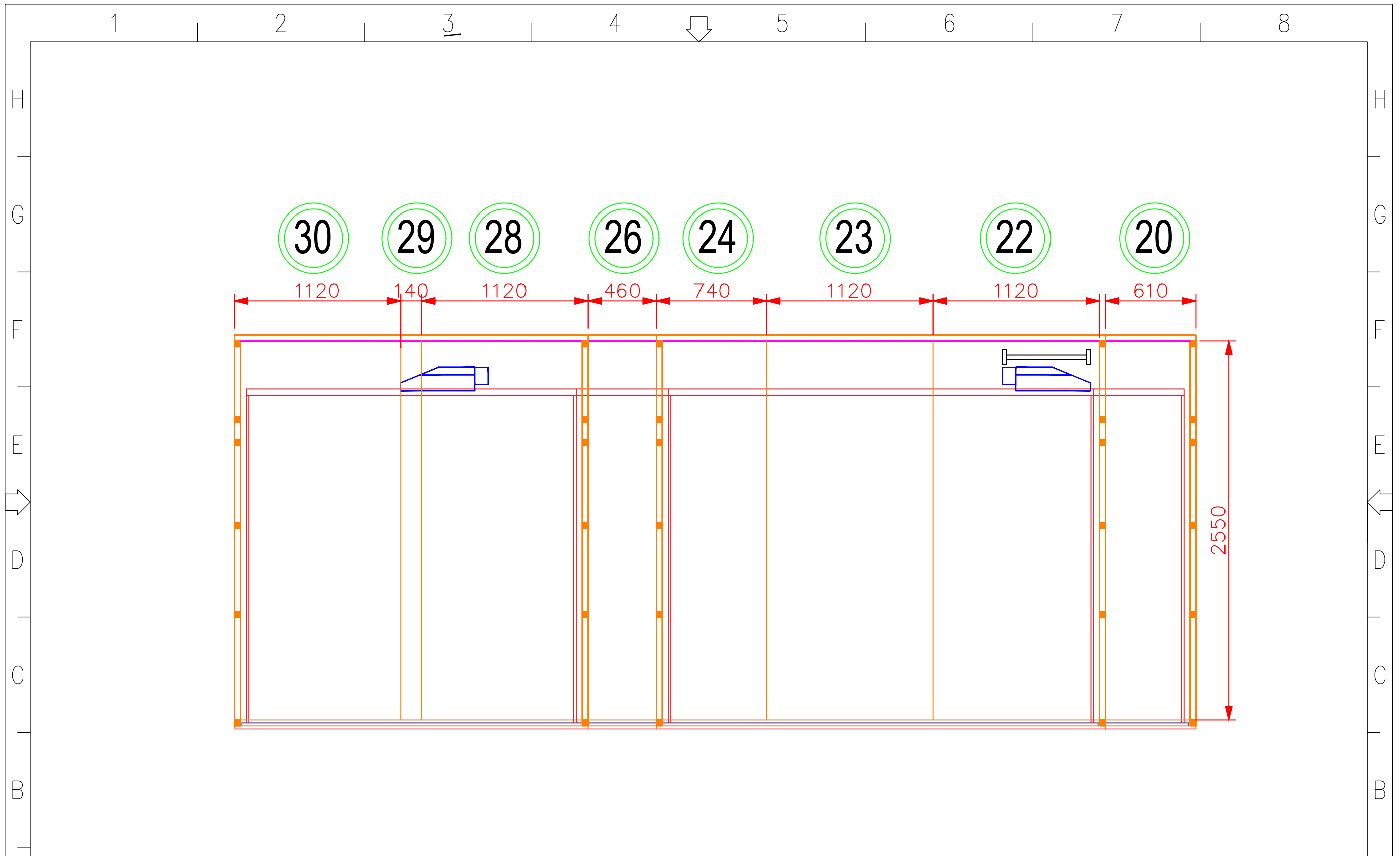

Project No: 2020xxx	Dwg No: -	Customer/Project Name
Rev No: 2		
Date: 02.11.2022	Dwg By: -	Model Type
Scale 1/50	All dimensions are millimeters.	Ingenia Ambition S
Size A3		

WALL PANELS RIGHT VIEW-D

A

A

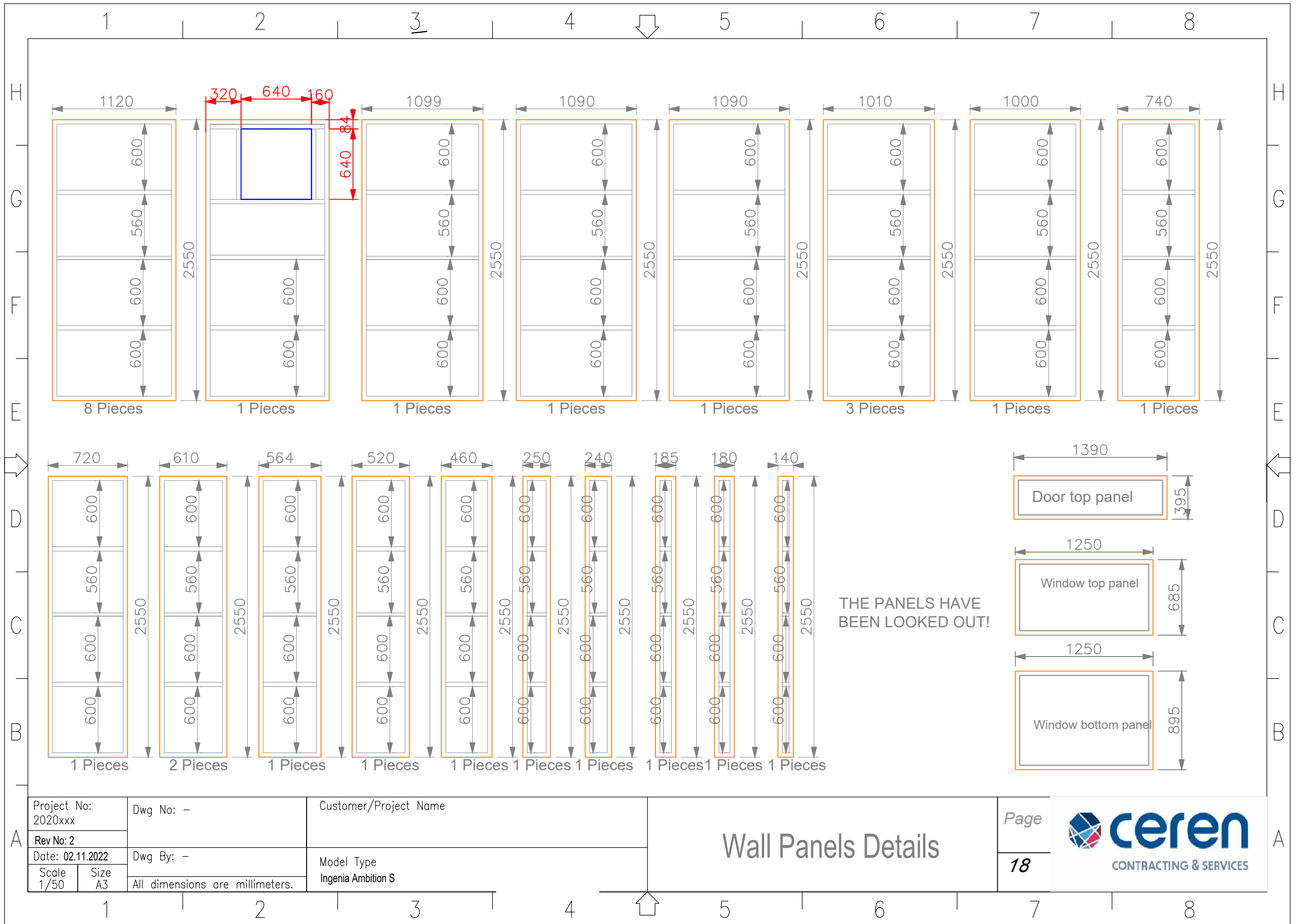

Project No: 2020xxx		Dwg No: -	Customer/Project Name
Rev No: 2			
Date: 02.11.2022		Dwg By: -	Model Type Ingenia Ambition S
Scale 1/50	Size A3	All dimensions are millimeters.	

Wall Panels Details



THE PANELS HAVE BEEN LOOKED OUT!

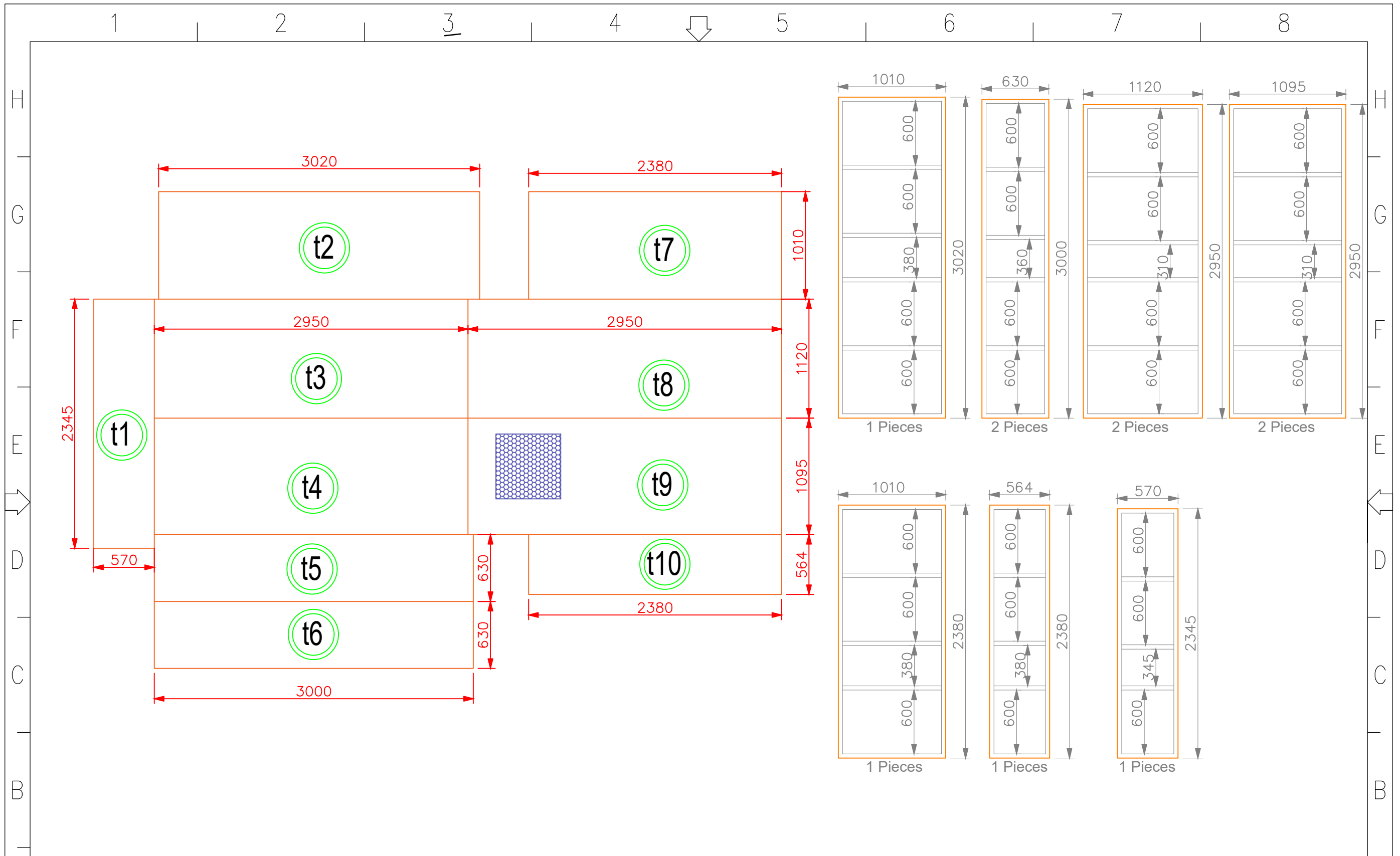

Project No:
2020xxx

Rev No: 2

Date: 02.11.2022

Scale
1/50

Dwg No: -

Dwg By: -

All dimensions are millimeters.

Customer/Project Name

Model Type
Ingenia Ambition S

CEILING PANELS DETAILS

Page

19



Project No: 2020xxx		Dwg No: -		Customer/Project Name		Page			
Rev No: 2		Dwg By: -		Model Type Ingenia Ambition S		19			
Date: 02.11.2022		All dimensions are millimeters.							
Scale 1/50	Size A3								

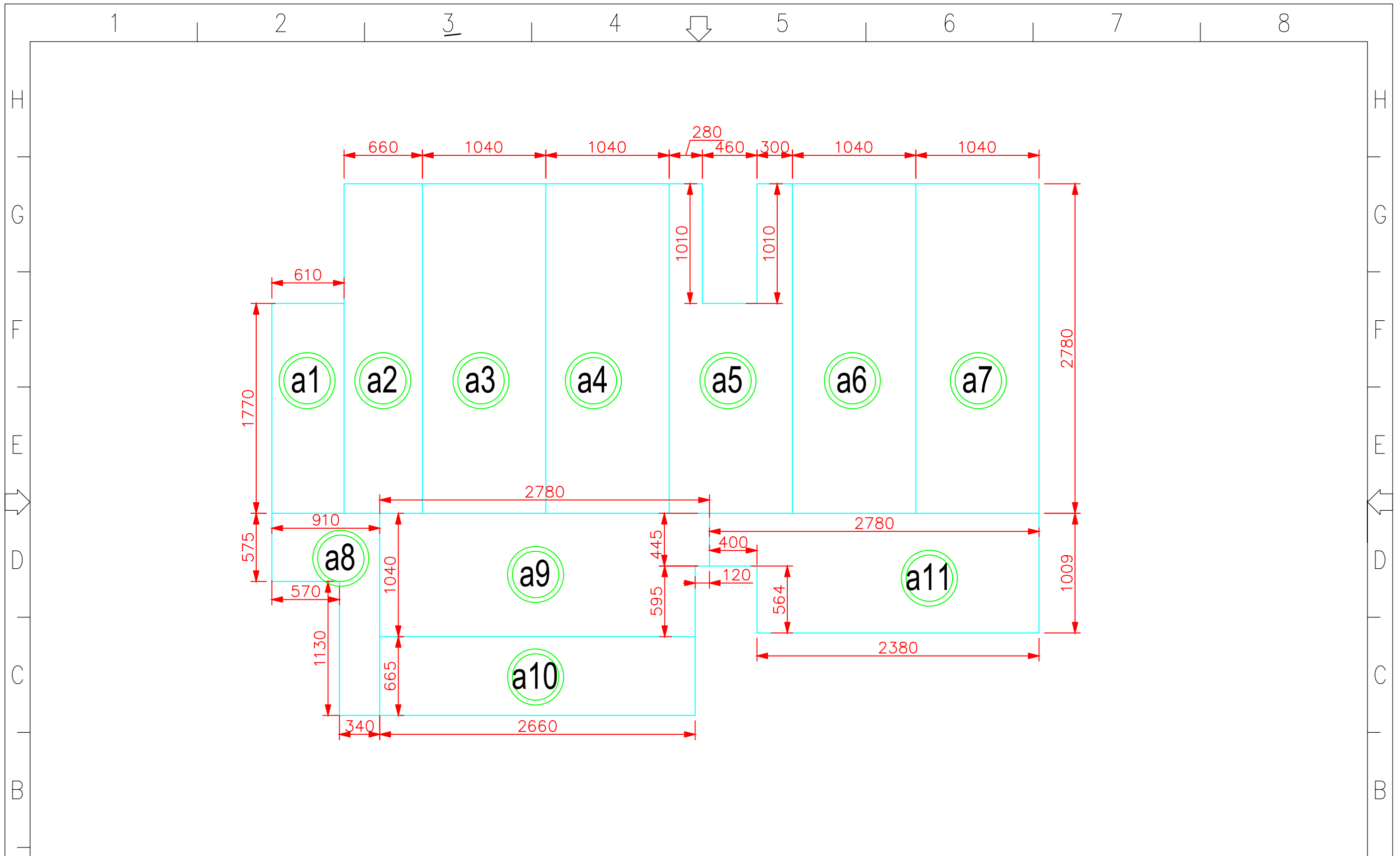

Project No:
2020xxx

Rev No: 2

Date: 02.11.2022

Scale
1/50

Dwg No: -

Dwg By: -

All dimensions are millimeters.

Customer/Project Name

Model Type
Ingenia Ambition S

Lower floor ground 18mm MDF

Page
20



A

A

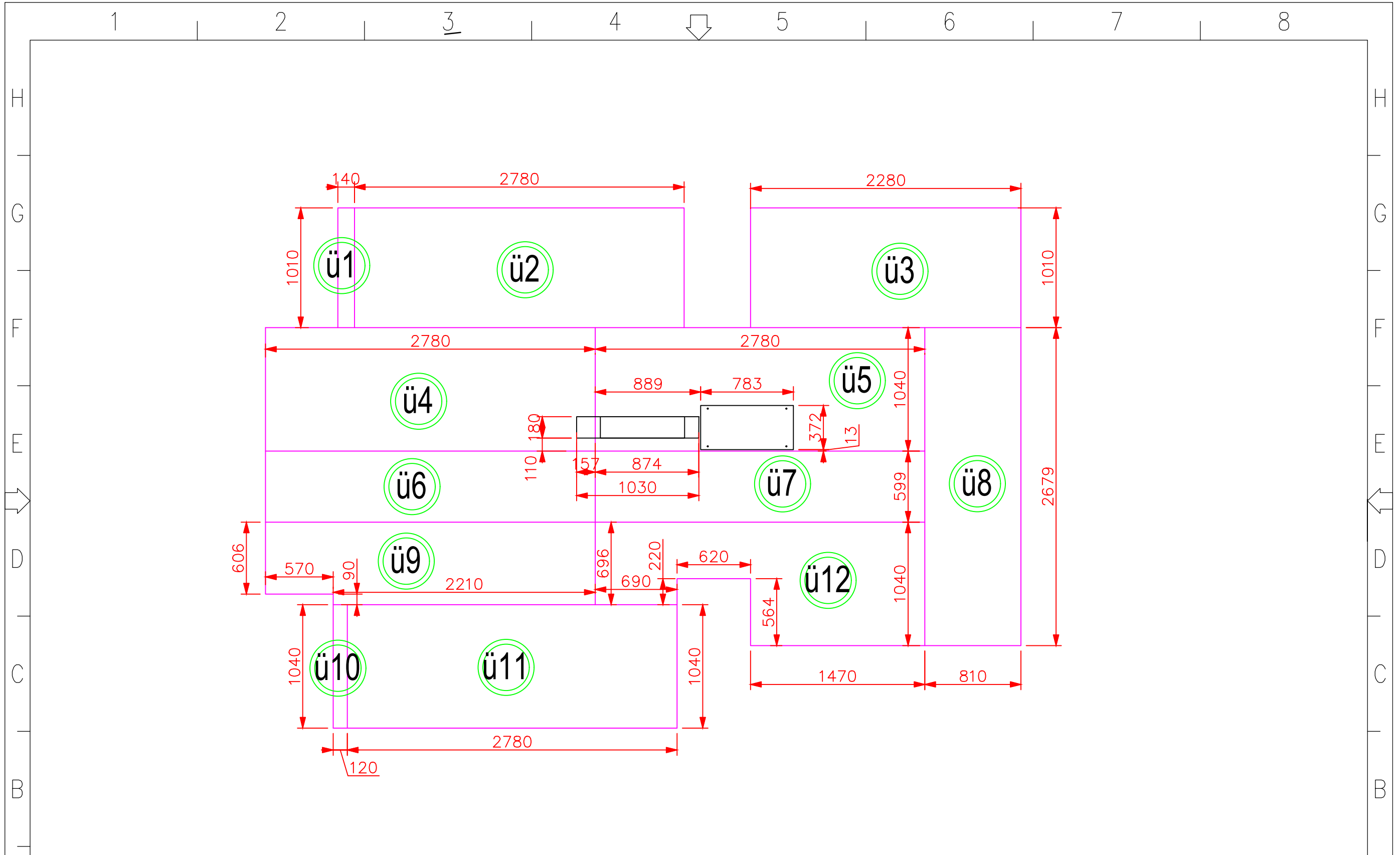

Project No:
2020xxx

Rev No: 2

Date: 02.11.2022

Scale
1/50

Dwg No: -

Dwg By: -

All dimensions are millimeters.

Customer/Project Name

Model Type
Ingenia Ambition S

Upper floor ground 18mm MDF

Page
21



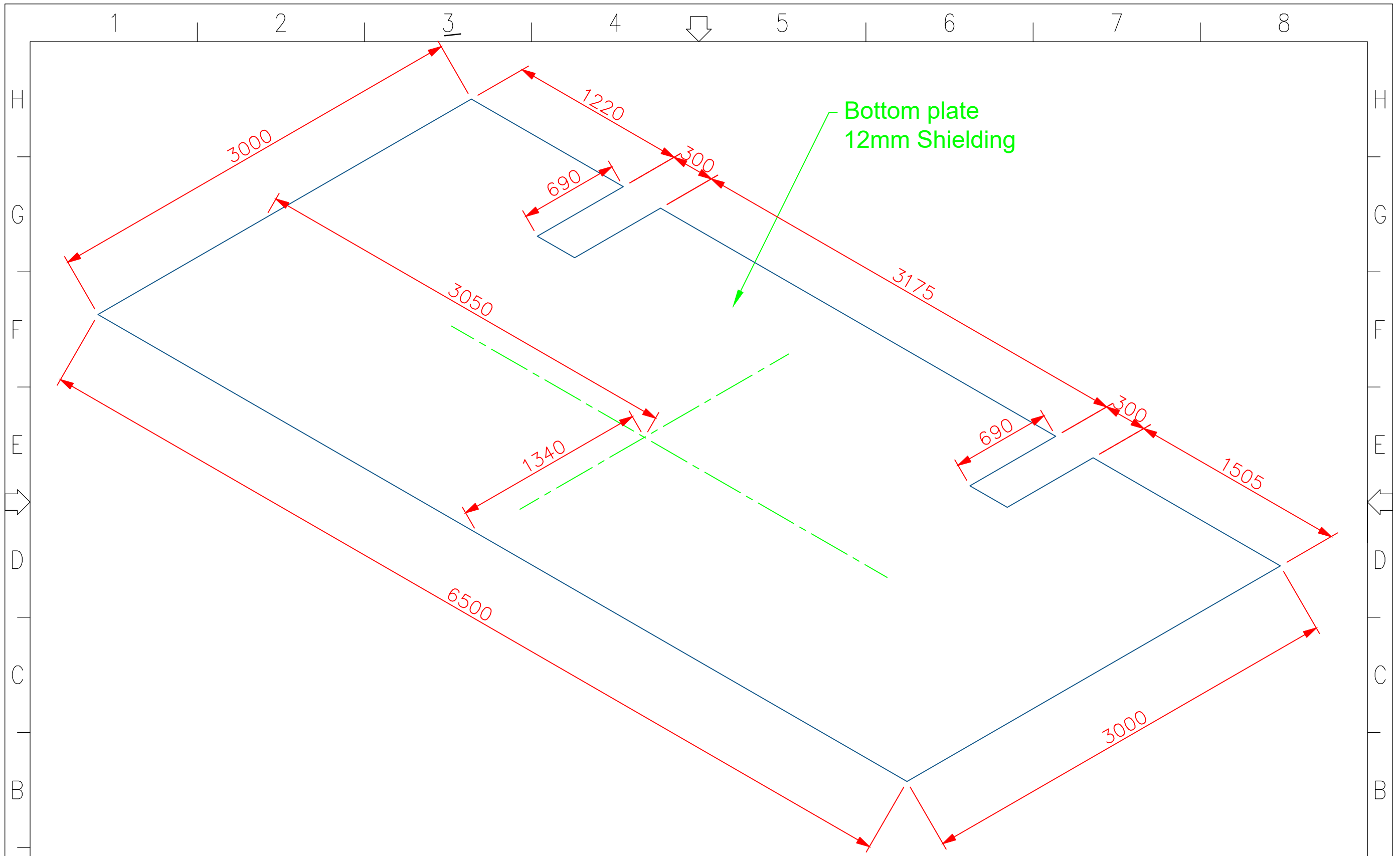

Project No: 2020xxx		Dwg No: -		Customer/Project Name		Page	 CONTRACTING & SERVICES
Rev No: 2							
Date: 02.11.2022		Dwg By: -		Model Type		22	
Scale 1/50	Size A3	All dimensions are millimeters.		Ingenia Ambition S			

Magnet Shielding

A

A

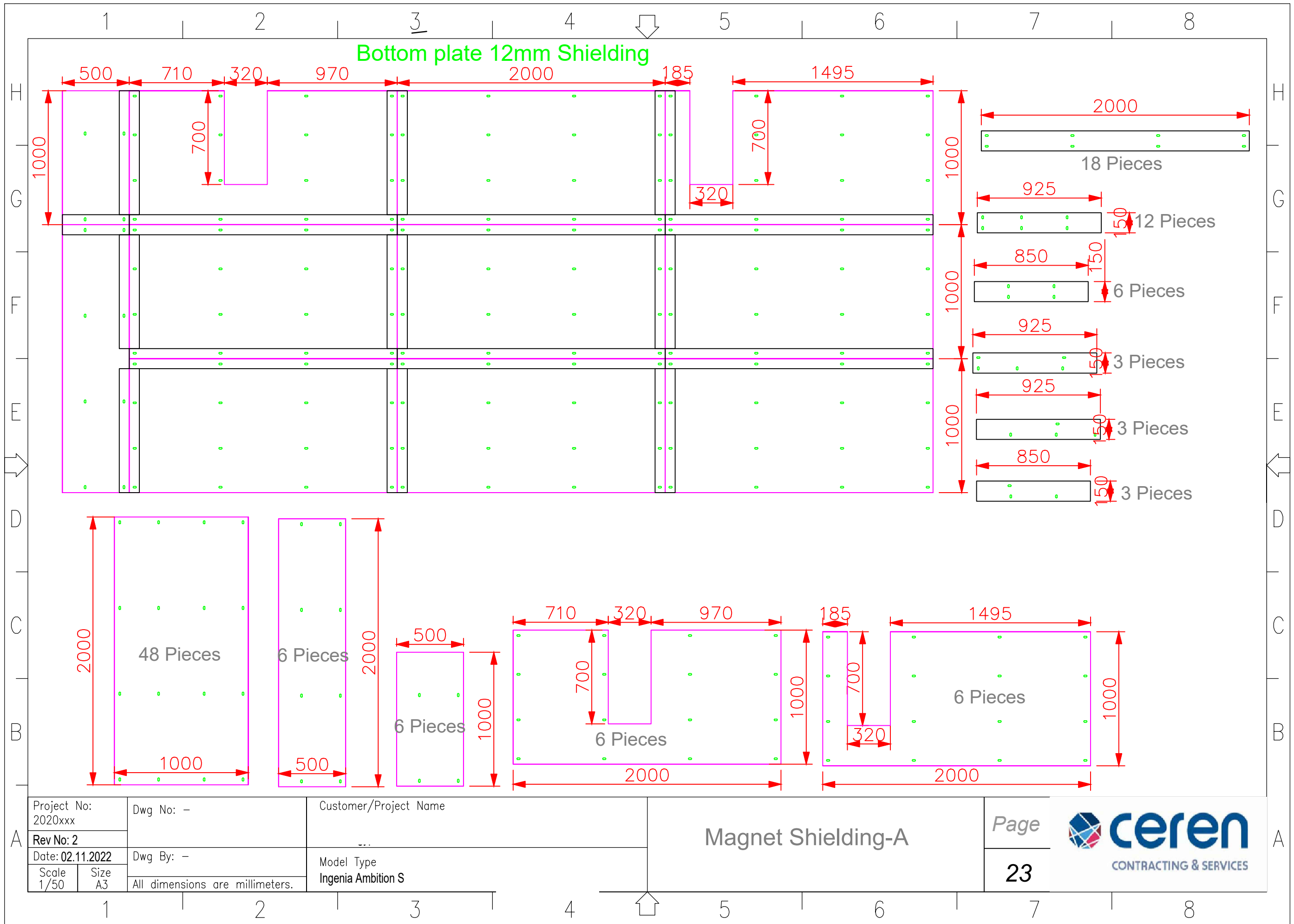

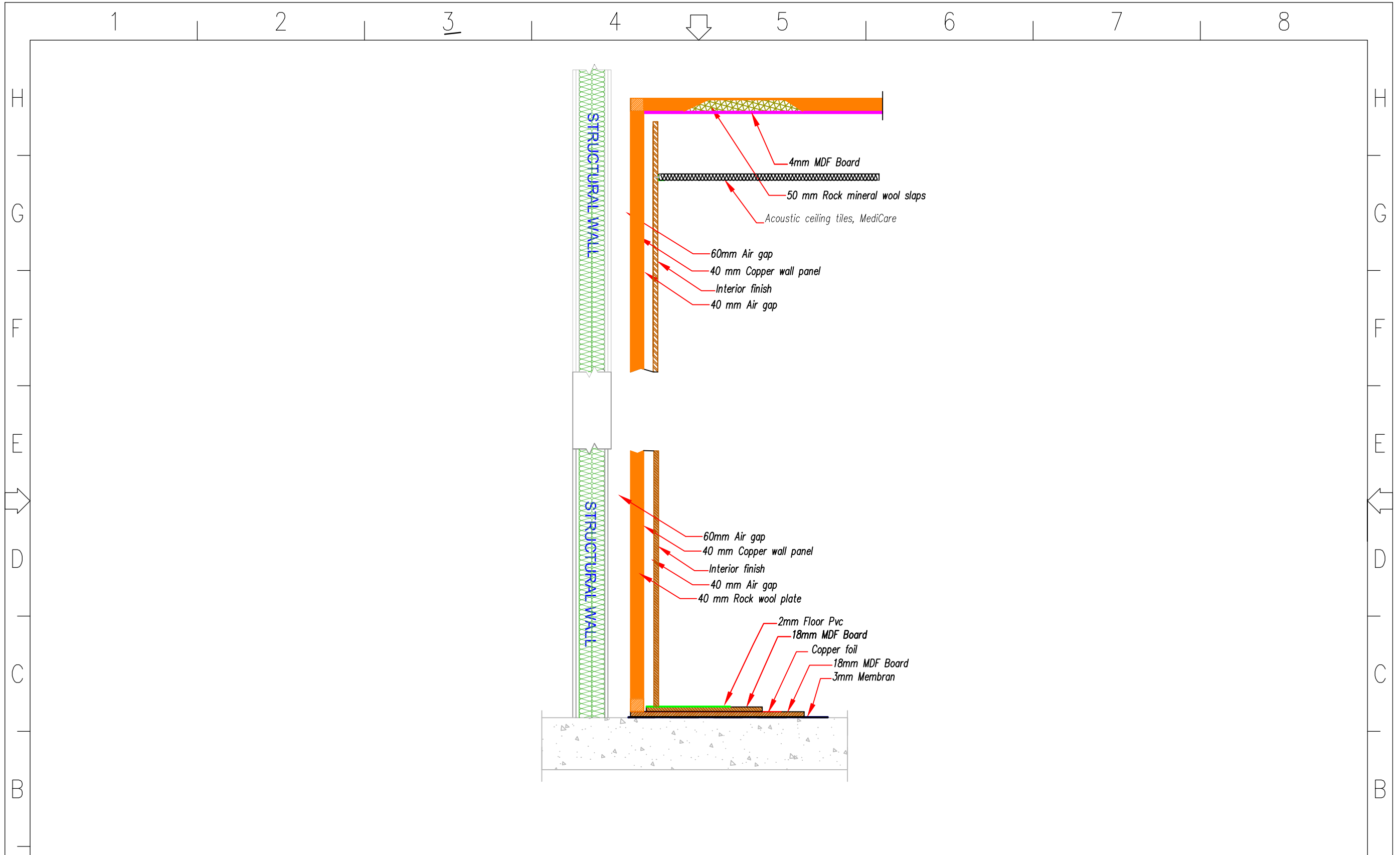

Project No: 2020xxx		Dwg No: -	Customer/Project Name
Rev No: 2			
Date: 02.11.2022		Dwg By: -	Model Type Ingenia Ambition S
Scale 1/50	Size A3		

RF Enclosure Details, Wall Panel

Page

24



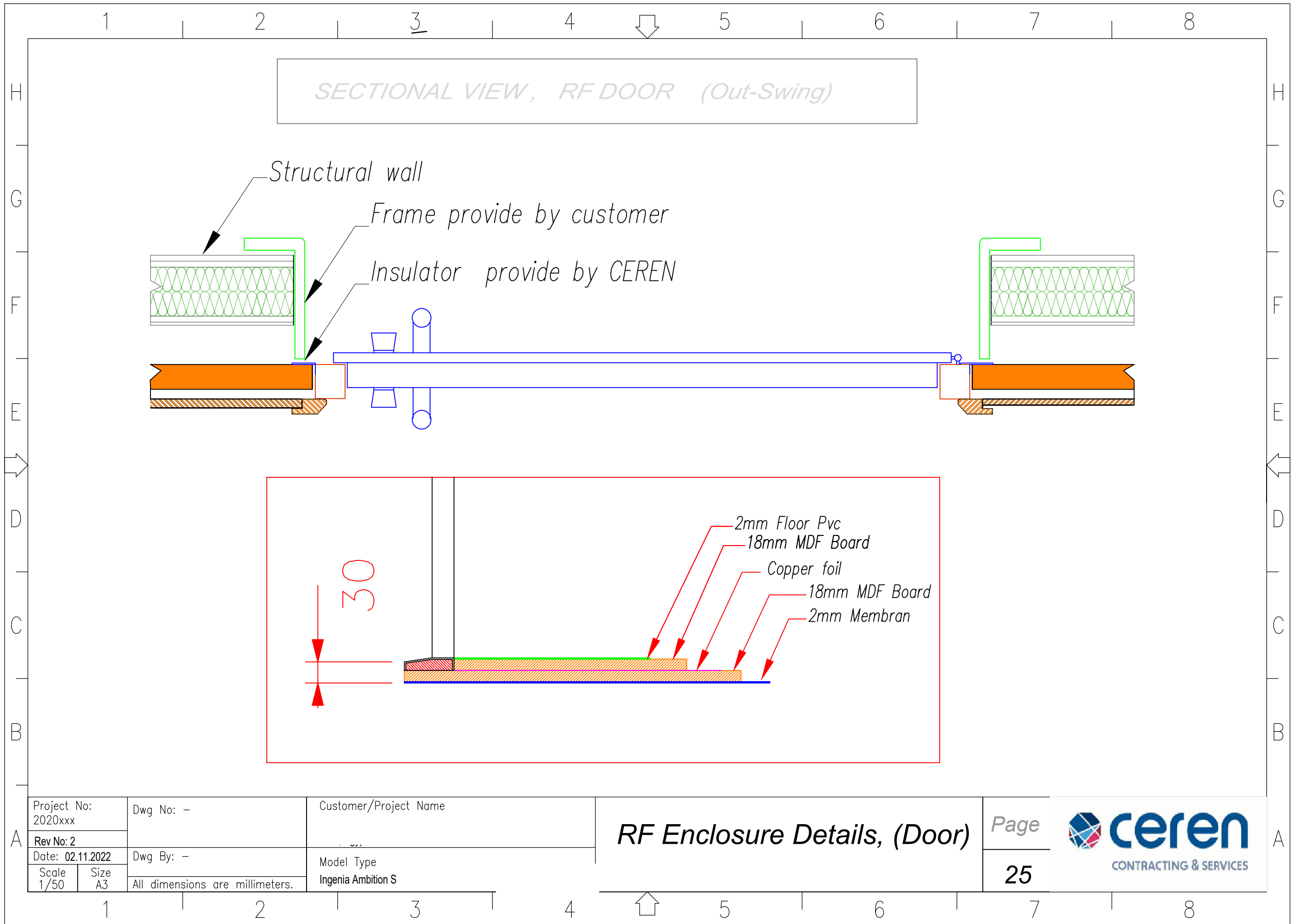

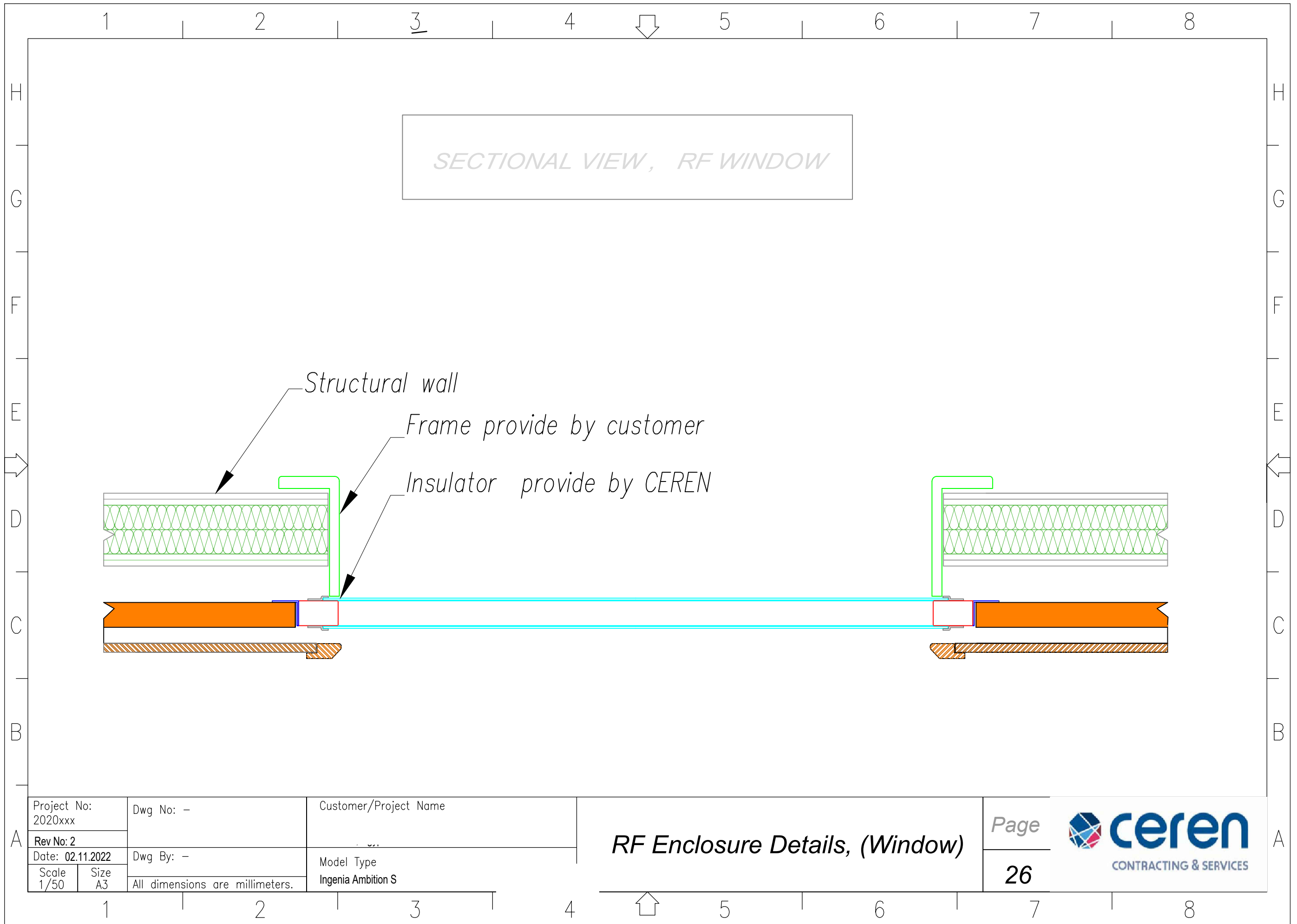

Project No:
2020xxx

Dwg No: -

Customer/Project Name

Rev No: 2
Date: 02.11.2022

Dwg By: -

Model Type
Ingenia Ambition S

Scale 1/50
Size A3

All dimensions are millimeters.

RF Enclosure Details, (Window)

Page

26



A

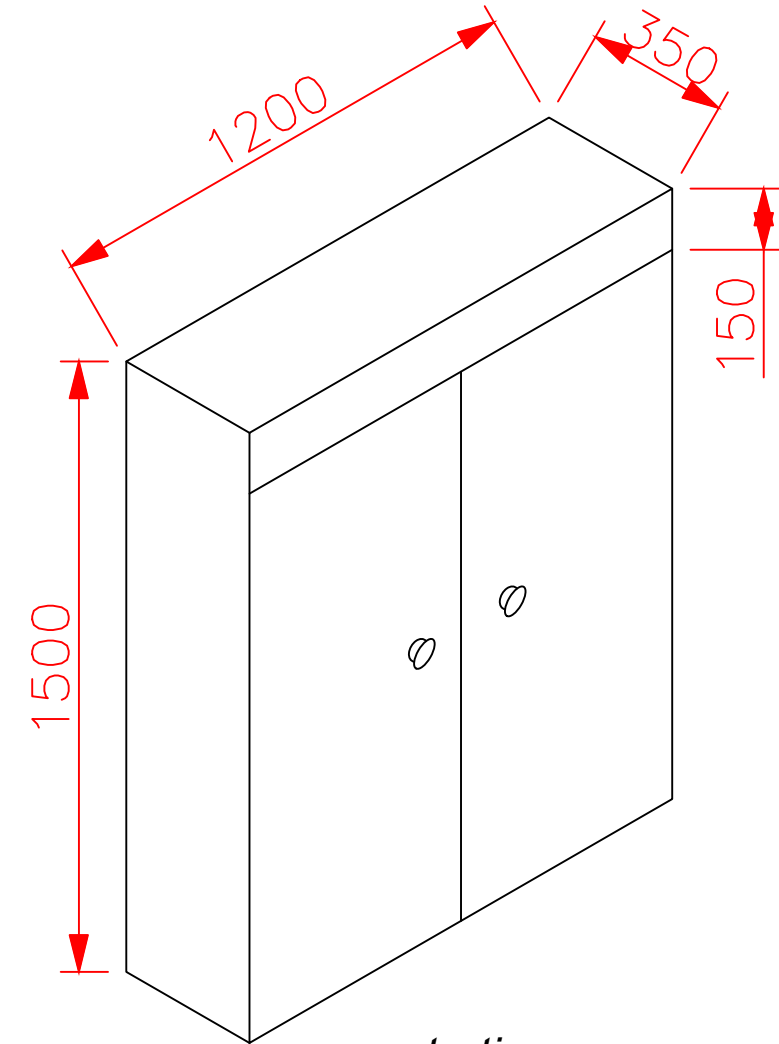
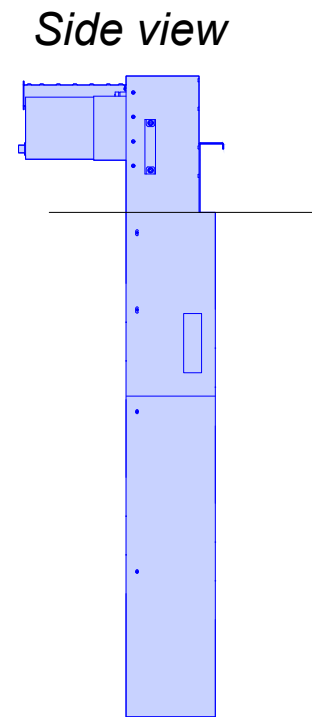
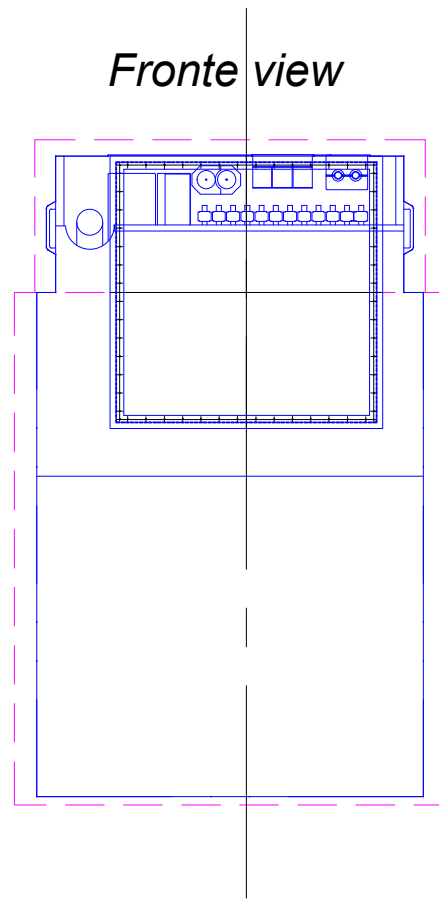
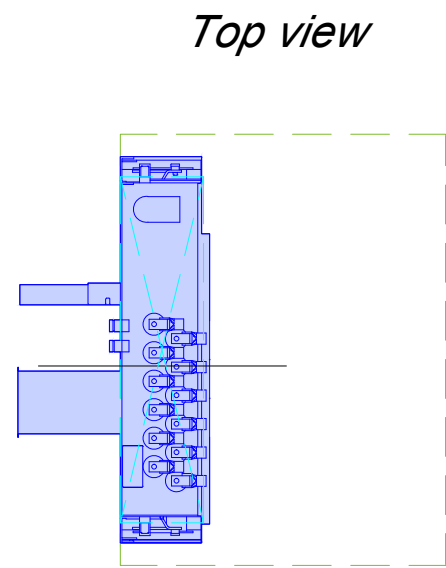

*penetration
locker!*

Project No:
2020xxx
Rev No: 2
Date: 02.11.2022
Scale
1/50

Dwg No: -
Dwg By: -
All dimensions are millimeters.

Customer/Project Name
Model Type
Ingenia Ambition S

System filter BOX

Page

27

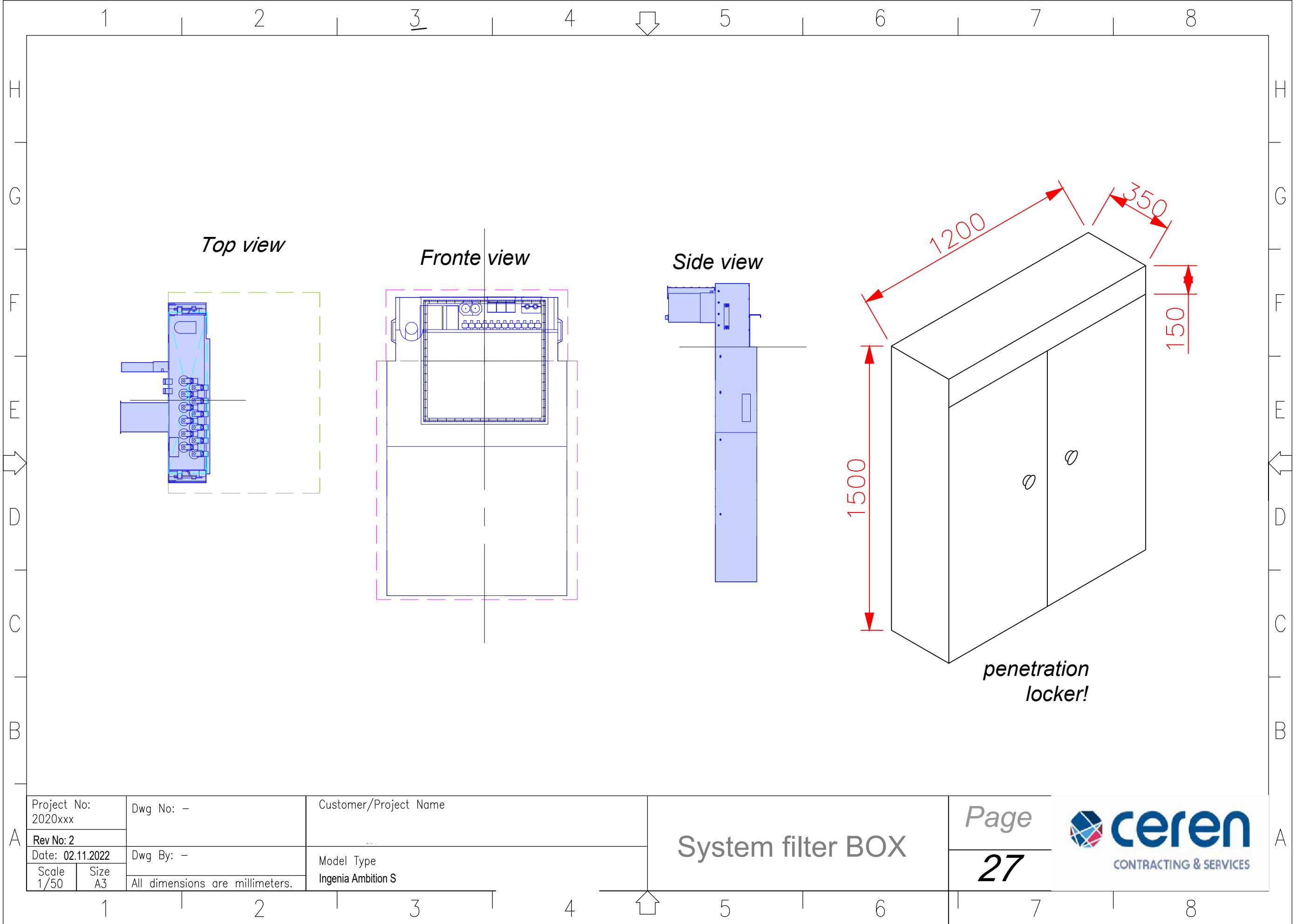

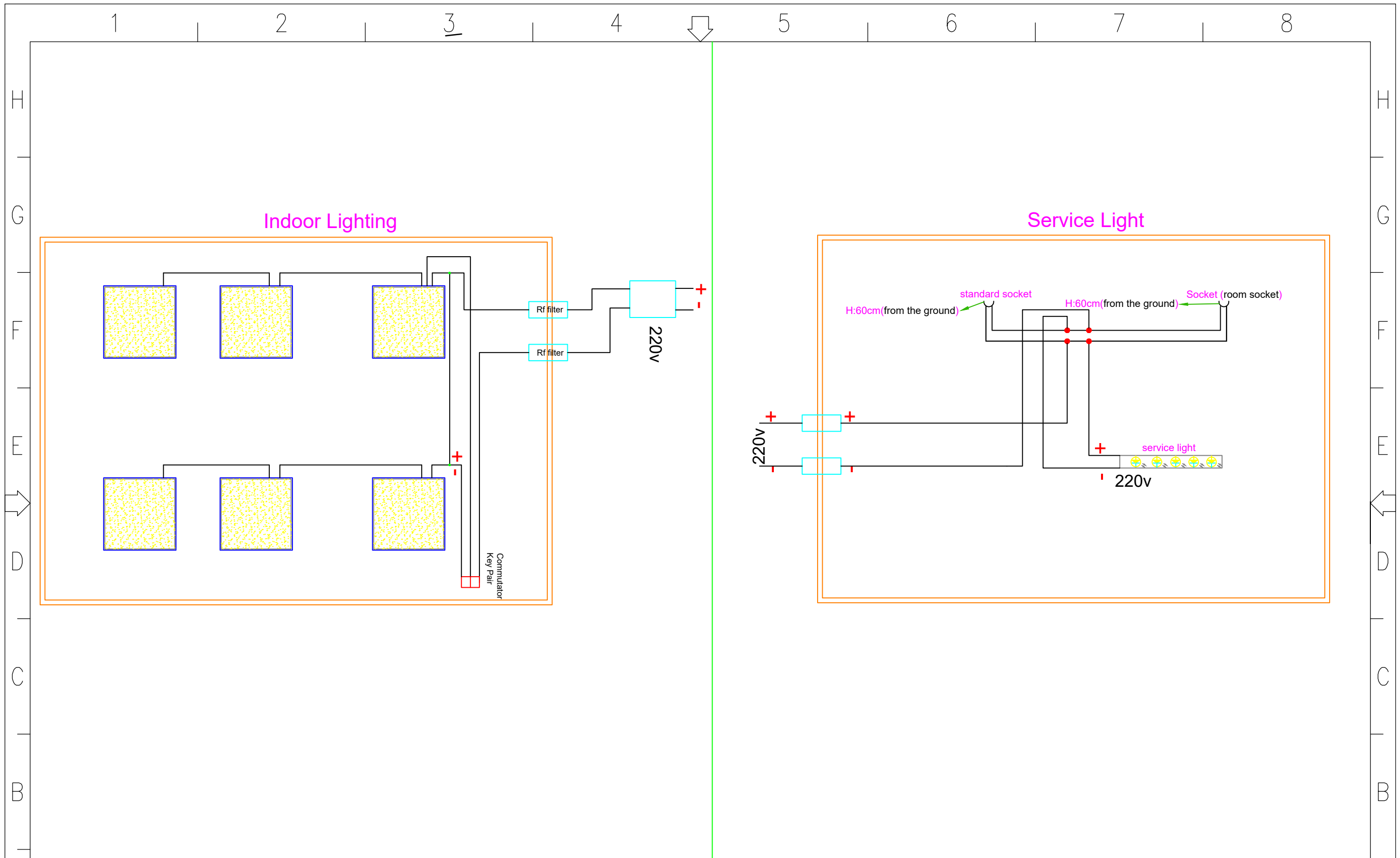

Project No: 2020xxx		Dwg No: -		Customer/Project Name		<i>Room lighting drawing</i>	Page 28	 CONTRACTING & SERVICES
Rev No: 2		Dwg By: -		Model Type Ingenia Ambition S				
Date: 02.11.2022		All dimensions are millimeters.						
Scale 1/50	Size A3							